

# MagicDrill DRV



P M K<sub>1</sub> K<sub>2</sub>



**WINTER PROMOTION**

## MagicDrill DRV

### HIGH PRECISION DESIGN

Highly efficient solution for excellent all-round drilling performance. KDA series comes in two coated types: Type N without coolant, and Type C with internal coolant.



Purchase 20 outer- + 20 inner-edge inserts and get toolholder with discount + **1 Kyocera kitchen knife** free of charge!

**ORDER NOW**



#### General conditions

- The promotion is valid from October 2nd 2024 until March 27th 2025.
- Different chipbreakers can be mixed to reach the required insert quantity.
- Orders on schedule, combination with other special offer, cancellation, exchange and return cannot be accepted.
- Errors excepted, with reservation subject to change.

THE NEW VALUE FRONTIER



High efficiency indexable insert drill

**DRV**

# MagicDrill **DRV**

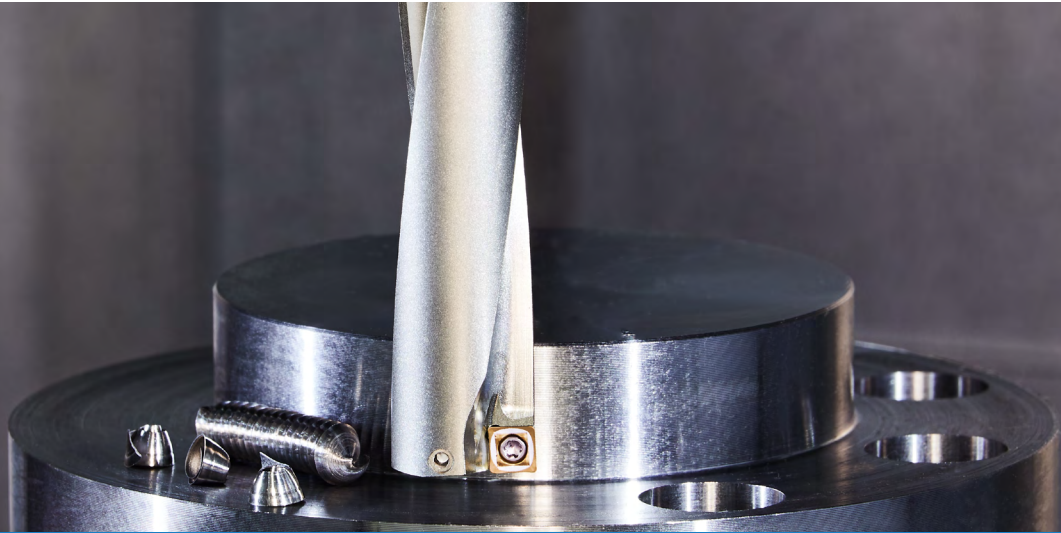

**Economical inserts with 4 cutting edges**  
**Excellent chip evacuation with 6D maximum deep-hole drilling**

2D to 6D drilling lineup and 4 types of chipbreakers for various machining applications

High speed and highly efficient machining available with the combination of a CVD outer insert and PVD inner insert

Highly rigid design with chattering resistance. Excellent hole accuracy

DRV chamfering attachment



Inserts and toolholders  
lineup expansion

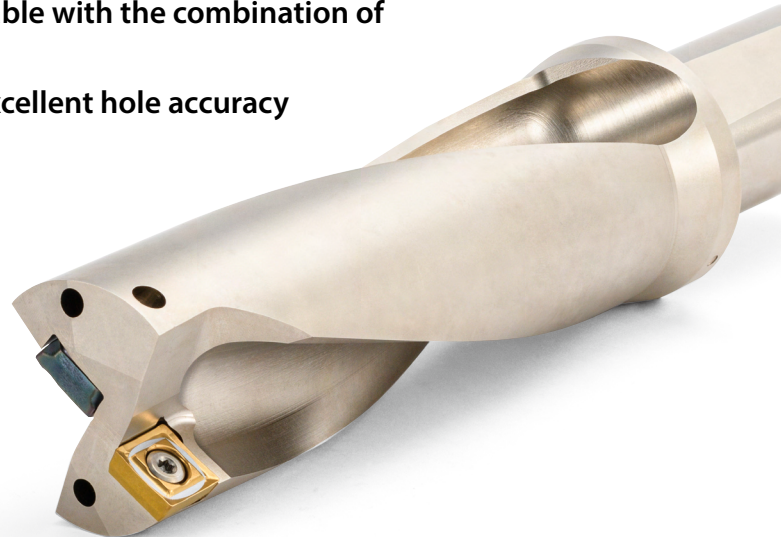

Expanded large toolholder lineup from  $\varnothing$  40 mm~ $\varnothing$  60 mm diameter

High efficiency indexable insert drill

# MagicDrill DRV

Economical inserts with 4 cutting edges. Excellent chip evacuation with 6D maximum deep-hole drilling. High speed and highly efficient machining available with the combination of CVD (outer edge) and pvd (inner edge) inserts

## 1 Excellent drilling precision with less variation in cutting diameter up to 6D drilling capabilities with a low cutting force design

Optimal web thickness reduces chattering with a low cutting force design

Web thickness comparison (In-house evaluation)

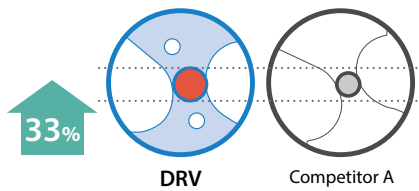

Comparison of cutting diameter variation (In-house evaluation)

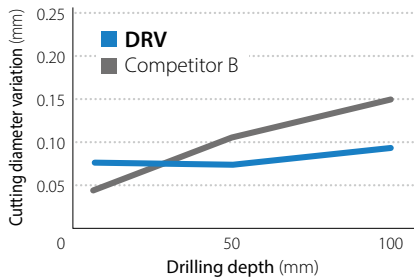

Cutting conditions:  $V_c = 150$  m/min,  $f = 0.06$  mm/rev  
Cutting dia.  $\phi 20(5D)$ , wet, workpiece: S50C

Cutting force comparison (In-house evaluation)

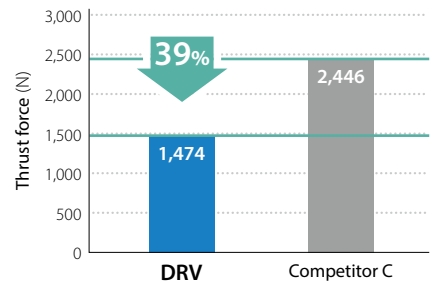

Cutting conditions:  $V_c = 200$  m/min,  $f = 0.12$  mm/rev  
Cutting dia.  $\phi 20(3D)$ , wet, workpiece: S50C

## 2 Unique insert design to control chip flow

Outer edge Smooth chip evacuation with compact chips

Unique insert pattern to differentiate between outside and inside inserts



Chip shape comparison of outer insert cutting edge (In-house evaluation)



Cutting conditions:  $V_c = 150$  m/min,  $f = 0.06$  mm/rev, cutting dia.  $\phi 20(3D)$ , wet, workpiece: S50C

Inner edge Excellent chip evacuation with 6D maximum deep-hole drilling

Weight per unit of length for chips generated by the inner edge (In-house evaluation)



DRV  
80 mg/mm

Competitor E  
151 mg/mm



Pitch comparison of chips generated by the inner edge (In-house evaluation)

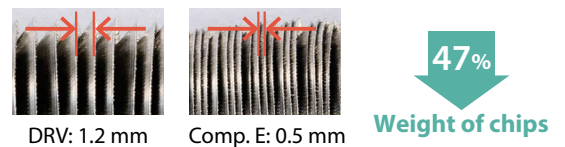

Cutting conditions:  $V_c = 250$  m/min,  $f = 0.08$  mm/rev, cutting dia.  $\phi 20(5D)$ , wet, workpiece: SUS304

### 3 CVD insert on the outer edge for highly efficient machining

High speed and highly efficient machining available with the combination of CVD (outer edge) and PVD (inner edge) inserts

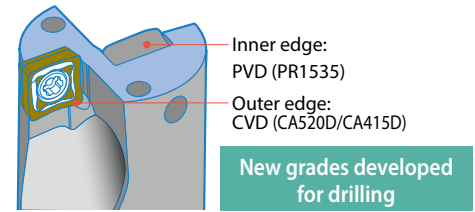

Recommended cutting conditions (Max. value)

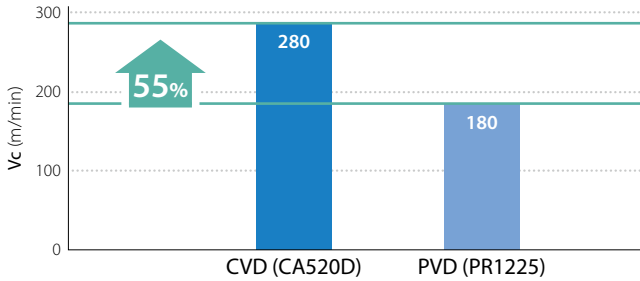

Cutting dia.  $\phi 20(3D)$ , workpiece: S50C

Wear resistance comparison (In-house evaluation)

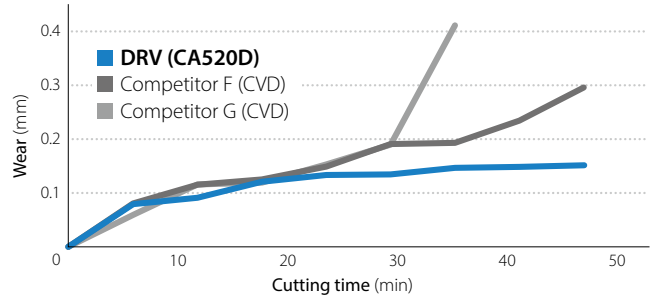

Cutting conditions:  $V_c = 200$  m/min,  $f = 0.12$  mm/rev, cutting dia.  $\phi 20(3D)$ , wet, workpiece: SCM440H

### 4 Economical 4-edge inserts 4 types of chipbreakers for various machining applications

#### General purpose: GM chipbreaker

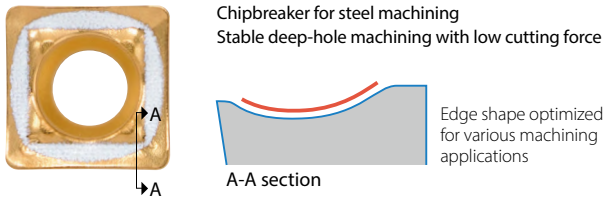

#### Tough edge: GH chipbreaker

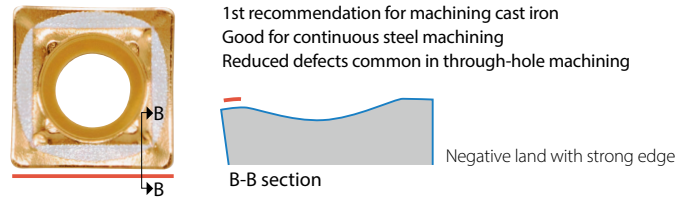

#### For stainless steel machining: SM chipbreaker

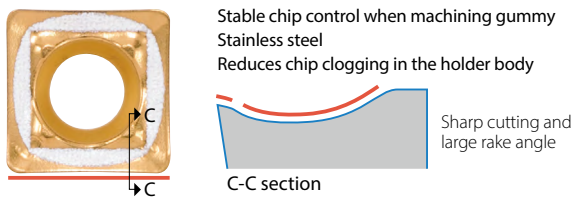

#### Chip control comparison (In-house evaluation)



Cutting conditions:  $V_c = 100$  m/min,  $f = 0.1$  mm/rev, cutting dia.  $\phi 20(3D)$ , drilling depth 60 mm, wet, workpiece: SUS304

#### Comparison of remaining chips (In-house evaluation)



Cutting conditions:  $V_c = 150$  m/min,  $f = 0.08$  mm/rev, cutting dia.  $\phi 25(5D)$ , drilling depth 98 mm, wet, workpiece: SUS304

#### For machining soft steel and SS material: XM chipbreaker

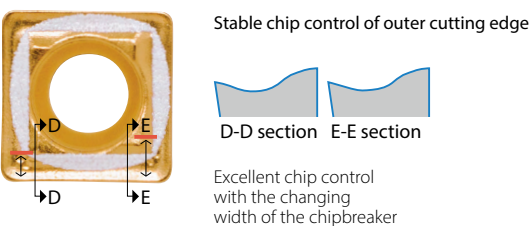

#### Chip control comparison (In-house evaluation)

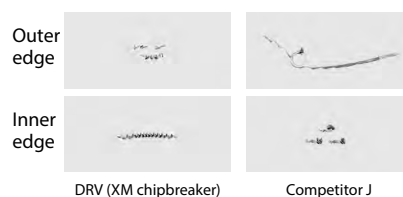

Cutting conditions:  $V_c = 200$  m/min,  $f = 0.12$  mm/rev, cutting dia.  $\phi 16(3D)$ , drilling depth 48 mm, wet, workpiece: SS400

Chipbreaker selection chart  $\rightarrow$  P.3

5

Applicable to a wide range of machining applications

NEW

Greatly enhanced large diameter toolholders

Full toolholder lineup available

Length from 2D to 6D, diameter from  $\varnothing$  12 mm to  $\varnothing$  60 mm



Chamfering attachment



Expanded large holder lineup from  $\varnothing$  40 mm~ $\varnothing$  60 mm diameter  
(Picture at right: S40-DRV550M-3-17)



Wide lineup of toolholder from 2D to 6D

## Chipbreaker selection chart

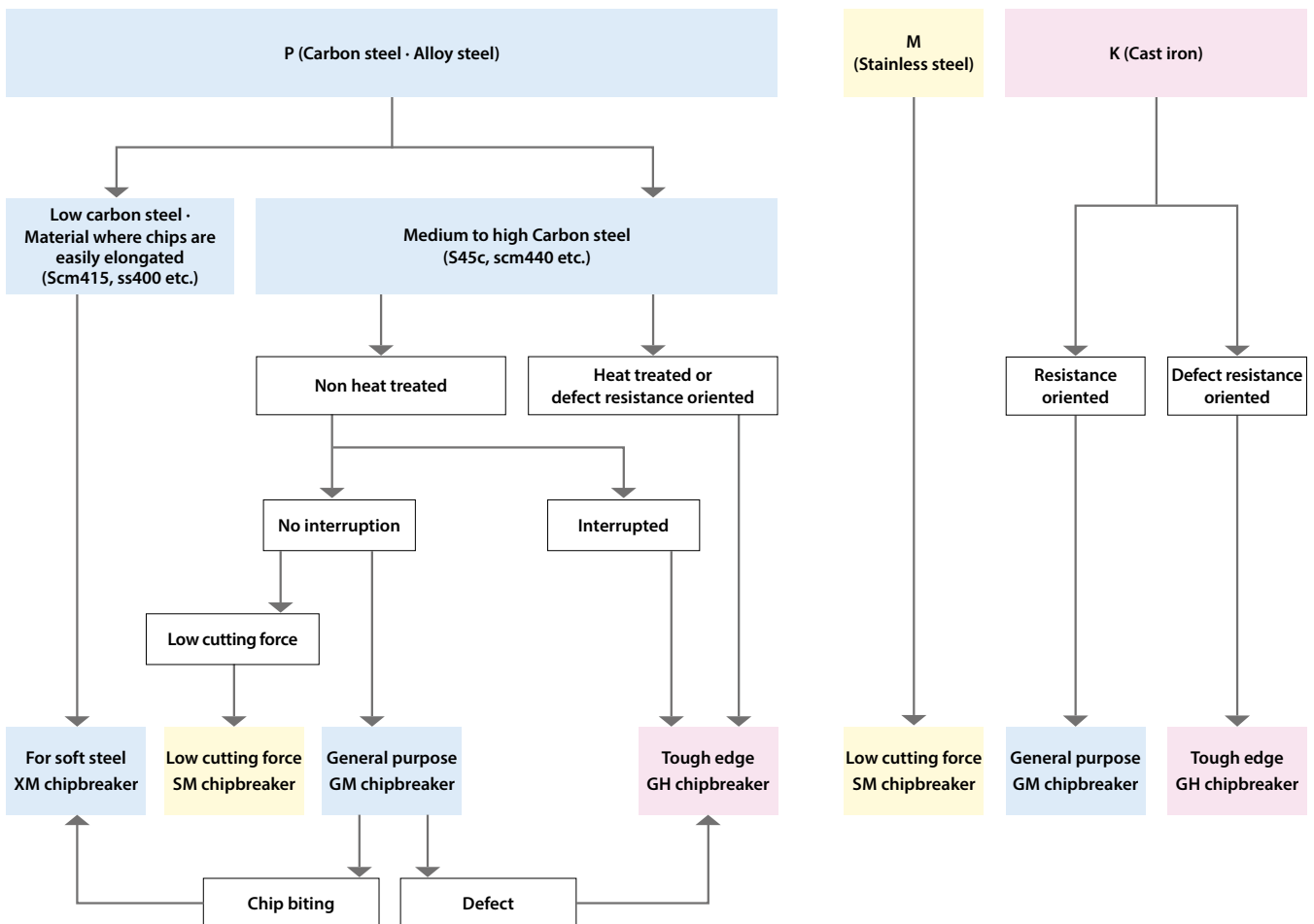

Case studies

**Housing SCM420**

Vc = 125 m/min (n = 1,660 min<sup>-1</sup>)  
 f = 0.08 mm/rev (Vf = 133 mm/min)  
 Drilling depth 45 mm  
 Wet (External coolant)  
 S25-DRV240M-4-07  
 SCMT070305GM-E PR1225  
 SCMT070310GM-I PR1535

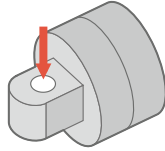

Cutting time

**DRV (ø24-4D) 16 sec**

50%  
or more

Competitor K (ø24-4D) 35 sec

Chattering and chip biting occurred in low rigidity workpiece of Competitor K. Speed was reduced to Vc = 60 m/min. DRV finely divided chips for stable machining at Vc = 125 m/min.

(User evaluation)

**Nipple S20CF**

Vc = 230 m/min (n = 3,330 min<sup>-1</sup>)  
 f = 0.13 mm/rev (Vf = 433 mm/min)  
 Drilling depth 60 mm(4D)  
 30 mm(2D)  
 Wet (Internal coolant)  
 S25-DRV220M-4-06 (4D)  
 S25-DRV220M-2-06 (2D)  
 SCMT060205-GM-E PR1225  
 SCMT060210-GM-I PR1535

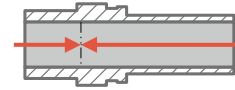

Process2  
Drilling depth 30 mm (2D)

Process1  
Drilling depth 60 mm (4D)

Cutting time

**DRV (ø24-4D/2D) 12 sec**

40%

Competitor L (ø22-4D/2D) 20 sec

Chattering and deflection occurred with Competitor L. DRV showed stable machining and a shorter cutting time even when the cutting conditions were increased to 1.6 times or more.

(User evaluation)

**Valve Body SS400**

Vc = 220 mm/min (n = 3,200 min<sup>-1</sup>)  
 f = 0.05 mm/rev (Vf = 160 mm/min)  
 Cutting depths: 50mm (Blind hole/Through-hole)  
 Wet (Internal coolant)  
 S25-DRV220M-5-06  
 SCMT060205-GM-E PR1225  
 SCMT060210-GM-I PR1535

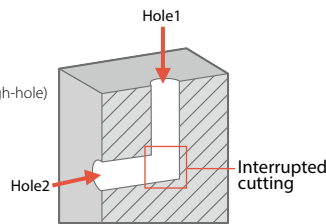

Cutting time

**DRV (ø22-5D) 14 sec**

30%  
or more

Competitor M (ø22-5D) 22 sec

Competitor M: Chattering occurred in the continuous part and then vibration was bigger in the crossed-hole.

DRV: There was no chattering even when increasing cutting speed and there was low vibration in the crossed-hole. The DRV achieved 1.5 times machining efficiency.

(User evaluation)

**Piston SCM440**

Vc = 250 mm/min (n = 3,185min<sup>-1</sup>)  
 f = 0.09 mm/rev (Vf = 290 mm/min)  
 Cutting depths: 70 mm (Blind hole)  
 Wet (Internal coolant)  
 S25-DRV250M-4-07  
 SCMT070305-GM-E CA520D  
 SCMT070310-GM-I PR1535

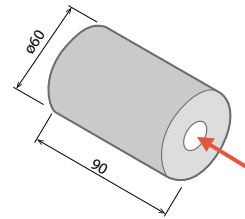

Cutting time

**DRV (ø25-4D) 14 sec**

25%

Competitor N (ø25-4D) 19 sec

Competitor N: Loud chattering noise occurred.

DRV: Maintained stable machining. No chattering even at 1.5 times faster cutting speed.

(User evaluation)

# DRV toolholder

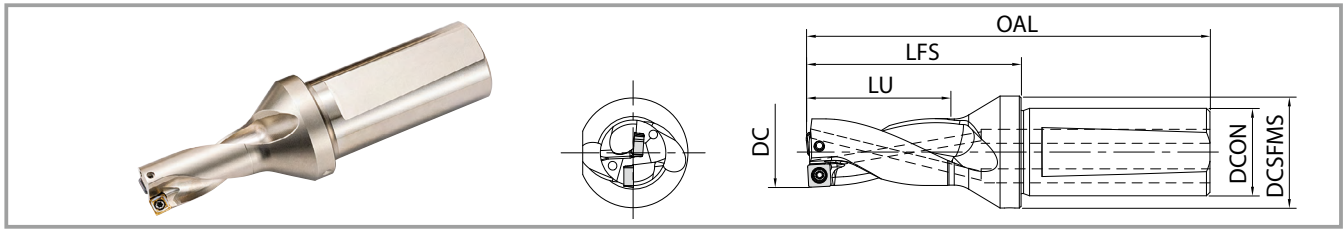

## Toolholder dimensions

2D

(Drilling depth: 2 × DC)

Description	Availability	No. of inserts	Dimensions (mm)						Max. radial offset (mm)	Spare parts		Applicable inserts
			DC	OAL	LFS	LU	DCON	DCSFMS		Clamp screw	Wrench	
S20- DRV120M-2-03	●	2	12	82	39	24	20	27	+0.25	SB-2037TRP	FTP-6	Outer edge LCMT030203-□□-E Inner edge LCMT030205-□□-I
DRV125M-2-03	●		12.5	83	40	25			+0.20			
DRV130M-2-03	●		13	84	41	26			+0.15			
DRV135M-2-03	●		13.5	85	42	27			+0.10			
S20- DRV140M-2-04	●	2	14	92	49	28	20	27	+0.40	SB-2037TRP	FTP-6	Outer edge SCMT040205-□□-E Inner edge SCMT040209-□□-I
DRV145M-2-04	●		14.5	93	50	29			+0.35			
DRV150M-2-04	●		15	94	51	30			+0.30			
DRV155M-2-04	●		15.5	95	52	31			+0.25			
S25- DRV160M-2-05	●	2	16	110	56	32	25	32	+0.40	SB-2041TRP	FTP-6	Outer edge SCMT050205-□□-E Inner edge SCMT050210-□□-I
DRV165M-2-05	●		16.5	111	57	33			+0.35			
DRV170M-2-05	●		17	112	58	34			+0.30			
DRV175M-2-05	●		17.5	113	59	35			+0.25			
DRV180M-2-05	●		18	114	60	36			+0.20			
DRV185M-2-05	●		18.5	115	61	37			+0.15			
S25- DRV190M-2-06	●	2	19	113	59	38	25	32	+0.65	SB-2555TRP	DTPM-8	Outer edge SCMT060205-□□-E Inner edge SCMT060210-□□-I
DRV195M-2-06	●		19.5	114	60	39			+0.60			
DRV200M-2-06	●		20	115	61	40			+0.55			
DRV205M-2-06	●		20.5	116	62	41			+0.50			
DRV210M-2-06	●		21	117	63	42			+0.45			
DRV215M-2-06	●		21.5	118	64	43			+0.35			
DRV220M-2-06	●		22	119	65	44			+0.30			
S25- DRV225M-2-07	●	2	22.5	120	66	45	25	32	+0.90	SB-3060TRP	DTPM-10	Outer edge SCMT070305-□□-E Inner edge SCMT070310-□□-I
DRV230M-2-07	●		23	121	67	46			+0.80			
DRV235M-2-07	●		23.5	122	68	47			+0.75			
DRV240M-2-07	●		24	123	69	48			+0.70			
DRV245M-2-07	●		24.5	124	70	49			+0.65			
DRV250M-2-07	●		25	125	71	50			+0.60			
DRV255M-2-07	●		25.5	126	72	51			+0.50			
DRV260M-2-07	●		26	127	73	52			+0.45			
S32- DRV270M-2-09	●	2	27	136	77	54	32	41	+1.05	SB-3573TRP	DTPM-10	Outer edge SCMT090405-□□-E Inner edge SCMT090410-□□-I
DRV280M-2-09	●		28	138	79	56			+0.95			
DRV290M-2-09	●		29	140	81	58			+0.85			
DRV300M-2-09	●		30	142	83	60			+0.75			
DRV310M-2-09	●		31	144	85	62			+0.60			
DRV320M-2-09	●		32	146	87	64			+0.50			

●: Available

# DRV toolholder

## Toolholder dimensions

2D

(Drilling depth: 2 × DC)

Description	Availability	No. of inserts	Dimensions (mm)					Max. radial offset (mm)	Spare parts		Applicable inserts	
			DC	OAL	LFS	LU	DCON		DCSFMS	Clamp screw		Wrench
S40- DRV330M-2-11	●	2	33	161	92	66	40	49	SB-4086TRP	DTPM-15	Outer edge SCMT110406-□□-E Inner edge SCMT110410-□□-I	
DRV340M-2-11	●		34	163	94	68						+1.25
DRV350M-2-11	●		35	165	96	70						+1.15
DRV360M-2-11	●		36	167	98	72						+1.00
DRV370M-2-11	●		37	169	100	74						+0.90
DRV380M-2-11	●		38	171	102	76						+0.80
DRV390M-2-11	●		39	173	104	78						+0.65
S40- DRV400M-2-14	●	2	40	181	112	80	40	49	SB-50120TRPH	TTP-20	Outer edge SCMT140508-□□-E Inner edge SCMT140510-□□-I	
NEW DRV410M-2-14	●		41	183	114	82						+1.75
DRV420M-2-14	●		42	185	116	84						+1.60
DRV430M-2-14	●		43	187	118	86						+1.50
DRV440M-2-14	●		44	189	120	88						+1.40
DRV450M-2-14	●		45	191	122	90		+1.30				
DRV460M-2-14	●		46	193	124	92		+1.15				
DRV470M-2-14	●		47	195	126	94		+1.05				
DRV480M-2-14	●		48	197	128	96		+0.95				
DRV490M-2-14	●		49	199	130	98		+0.80				
S40- DRV500M-2-17	●	2	50	198	129	100	40	59	SB-60130TRP	TTP-20	Outer edge SCMT170608-□□-E Inner edge SCMT170610-□□-I	
NEW DRV510M-2-17	●		51	200	131	102						+2.10
DRV520M-2-17	●		52	202	133	104						+1.95
DRV530M-2-17	●		53	204	135	106						+1.85
DRV540M-2-17	●		54	206	137	108						+1.75
DRV550M-2-17	●		55	208	139	110						+1.65
DRV560M-2-17	●		56	210	141	112		+1.50				
DRV570M-2-17	●		57	212	143	114		+1.40				
DRV580M-2-17	●		58	214	145	116		+1.30				
DRV590M-2-17	●		59	216	147	118		+1.15				
DRV600M-2-17	●		60	218	149	120		+1.05				
						64	+0.95					

When offset drilling, reduce feed rate to 0.08 mm/rev or less  
See page 21 for adjustable sleeve (SHE)

● : Available

### ■ Estimated cutting tolerance (2D)

DC	Estimated cutting tolerance (mm)
φ12 - φ60	+0.30 0

The above values are estimates.  
These values may change due to machine, workpiece, clamping power, and cutting conditions.



# DRV toolholder

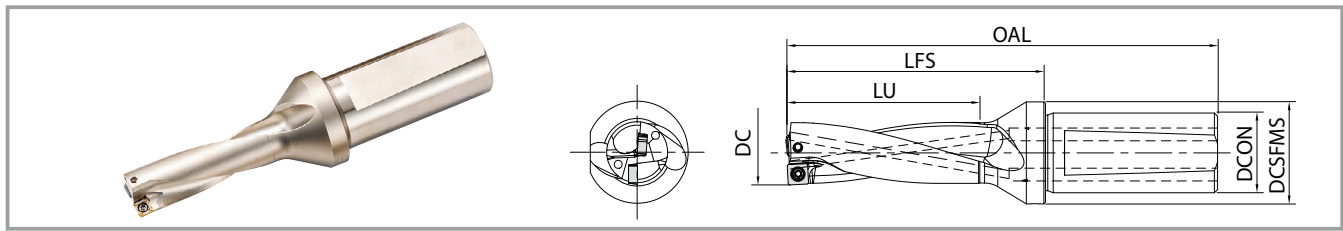

## Toolholder dimensions

3D

(Drilling depth: 3 × DC)

Description	Availability	No. of inserts	Dimensions (mm)						Max. radial offset (mm)	Spare parts		Applicable inserts
			DC	OAL	LFS	LU	DCON	DCSFMS		Clamp screw	Wrench	
S20- DRV120M-3-03	●	2	12	94	51	36	20	27	+0.25	SB-2037TRP	FTP-6	Outer edge LCMT030203-□□-E Inner edge LCMT030205-□□-I
DRV125M-3-03	●		12.5	96	53	37.5			+0.20			
DRV130M-3-03	●		13	97	54	39			+0.15			
DRV135M-3-03	●		13.5	99	56	40.5			+0.10			
S20- DRV140M-3-04	●	2	14	106	63	42	20	27	+0.40	SB-2037TRP	FTP-6	Outer edge SCMT040205-□□-E Inner edge SCMT040209-□□-I
DRV145M-3-04	●		14.5	108	65	43.5			+0.35			
DRV150M-3-04	●		15	109	66	45			+0.30			
DRV155M-3-04	●		15.5	111	68	46.5			+0.25			
S25- DRV160M-3-05	●	2	16	126	72	48	25	32	+0.40	SB-2041TRP	FTP-6	Outer edge SCMT050205-□□-E Inner edge SCMT050210-□□-I
DRV165M-3-05	●		16.5	127	73	49.5			+0.35			
DRV170M-3-05	●		17	129	75	51			+0.30			
DRV175M-3-05	●		17.5	130	76	52.5			+0.25			
DRV180M-3-05	●		18	132	78	54			+0.20			
DRV185M-3-05	●		18.5	133	79	55.5			+0.15			
S25- DRV190M-3-06	●	2	19	132	78	57	25	32	+0.65	SB-2555TRP	DTPM-8	Outer edge SCMT060205-□□-E Inner edge SCMT060210-□□-I
DRV195M-3-06	●		19.5	134	80	58.5			+0.60			
DRV200M-3-06	●		20	135	81	60			+0.55			
DRV205M-3-06	●		20.5	137	83	61.5			+0.50			
DRV210M-3-06	●		21	138	84	63			+0.45			
DRV215M-3-06	●		21.5	140	86	64.5			+0.35			
DRV220M-3-06	●		22	141	87	66			+0.30			
S25- DRV225M-3-07	●	2	22.5	142	88	67.5	25	32	+0.90	SB-3060TRP	DTPM-10	Outer edge SCMT070305-□□-E Inner edge SCMT070310-□□-I
DRV230M-3-07	●		23	144	90	69			+0.80			
DRV235M-3-07	●		23.5	145	91	70.5			+0.75			
DRV240M-3-07	●		24	147	93	72			+0.70			
DRV245M-3-07	●		24.5	148	94	73.5			+0.65			
DRV250M-3-07	●		25	150	96	75			+0.60			
DRV255M-3-07	●		25.5	151	97	76.5			+0.50			
DRV260M-3-07	●		26	153	99	78			+0.45			
S32- DRV265M-3-09	●	2	26.5	161	102	79.5	32	41	+1.15	SB-3573TRP	DTPM-10	Outer edge SCMT090405-□□-E Inner edge SCMT090410-□□-I
DRV270M-3-09	●		27	163	104	81			+1.05			
DRV275M-3-09	●		27.5	164	105	82.5			+1.00			
DRV280M-3-09	●		28	166	107	84			+0.95			
DRV285M-3-09	●		28.5	167	108	85.5			+0.90			
DRV290M-3-09	●		29	169	110	87			+0.85			
DRV295M-3-09	●		29.5	170	111	88.5			+0.80			
DRV300M-3-09	●		30	172	113	90			+0.75			
DRV305M-3-09	●		30.5	173	114	91.5			+0.65			
DRV310M-3-09	●		31	175	116	93			+0.60			
DRV315M-3-09	●		31.5	176	117	94.5			+0.55			
DRV320M-3-09	●		32	178	119	96			+0.50			

●: Available

# DRV toolholder

## Toolholder dimensions

3D

(Drilling depth: 3 × DC)

Description	Availability	No. of inserts	Dimensions (mm)					Max. radial offset (mm)	Spare parts		Applicable inserts	
			DC	OAL	LFS	LU	DCON		DCSFMS	Clamp screw		Wrench
S40- DRV330M-3-11	●	2	33	194	125	99	40	49	+1.25	SB-4086TRP	DTPM-15	Outer edge SCMT110406-□□-E Inner edge SCMT110410-□□-I
	●		34	197	128	102			+1.15			
	●		35	200	131	105			+1.00			
	●		36	203	134	108			+0.90			
	●		37	206	137	111			+0.80			
	●		38	209	140	114			+0.65			
	●		39	212	143	117			+0.55			
S40- NEW DRV400M-3-14	●	2	40	221	152	120	40	49	+1.75	SB-50120TRPH	TTP-20	Outer edge SCMT140508-□□-E Inner edge SCMT140510-□□-I
	●		41	224	155	123			+1.60			
	●		42	227	158	126			+1.50			
	●		43	230	161	129			+1.40			
	●		44	233	164	132			+1.30			
	●		45	236	167	135			+1.15			
	●		46	239	170	138		+1.05				
	●		47	242	173	141		+0.95				
	●		48	245	176	144		+0.80				
	●		49	248	179	147		+0.70				
S40- NEW DRV500M-3-17	●	2	50	248	179	150	40	59	+2.10	SB-60130TRP	TTP-20	Outer edge SCMT170608-□□-E Inner edge SCMT170610-□□-I
	●		51	251	182	153			+1.95			
	●		52	254	185	156			+1.85			
	●		53	257	188	159			+1.75			
	●		54	260	191	162			+1.65			
	●		55	263	194	165			+1.50			
	●		56	266	197	168		+1.40				
	●		57	269	200	171		+1.30				
	●		58	272	203	174		+1.15				
	●		59	275	206	177		+1.05				
	●		60	278	209	180		+0.95				

When offset drilling, reduce feed rate to 0.08 mm/rev or less  
See page 21 for adjustable sleeve (SHE)

● : Available

### ■ Estimated cutting tolerance (3D)

DC	Estimated cutting tolerance (mm)
φ12 - φ60	+0.30 0

The above values are estimates.  
These values may change due to machine, workpiece, clamping power, and cutting conditions.

# DRV toolholder

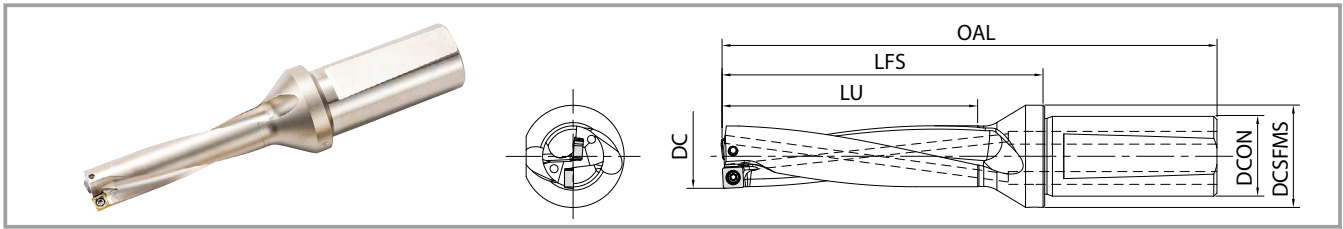

## Toolholder dimensions

4D

(Drilling depth: 4 × DC)

Description	Availability	No. of inserts	Dimensions (mm)						Max. radial offset (mm)	Spare parts		Applicable inserts
			DC	OAL	LFS	LU	DCON	DCSFMS		Clamp screw	Wrench	
S20- DRV120M-4-03	●	2	12	106	63	48	20	27	+0.25	SB-2037TRP	FTP-6	Outer edge LCMT030203-□□-E Inner edge LCMT030205-□□-I
DRV125M-4-03	●		12.5	108	65	50			+0.20			
DRV130M-4-03	●		13	110	67	52			+0.15			
DRV135M-4-03	●		13.5	112	69	54			+0.10			
S20- DRV140M-4-04	●	2	14	120	77	56	20	27	+0.40	SB-2037TRP	FTP-6	Outer edge SCMT040205-□□-E Inner edge SCMT040209-□□-I
DRV145M-4-04	●		14.5	122	79	58			+0.35			
DRV150M-4-04	●		15	124	81	60			+0.30			
DRV155M-4-04	●		15.5	126	83	62			+0.25			
S25- DRV160M-4-05	●	2	16	142	88	64	25	32	+0.40	SB-2041TRP	FTP-6	Outer edge SCMT050205-□□-E Inner edge SCMT050210-□□-I
DRV165M-4-05	●		16.5	144	90	66			+0.35			
DRV170M-4-05	●		17	146	92	68			+0.30			
DRV175M-4-05	●		17.5	148	94	70			+0.25			
DRV180M-4-05	●		18	150	96	72			+0.20			
DRV185M-4-05	●		18.5	152	98	74			+0.15			
S25- DRV190M-4-06	●	2	19	151	97	76	25	32	+0.65	SB-2555TRP	DTPM-8	Outer edge SCMT060205-□□-E Inner edge SCMT060210-□□-I
DRV195M-4-06	●		19.5	153	99	78			+0.60			
DRV200M-4-06	●		20	155	101	80			+0.55			
DRV205M-4-06	●		20.5	157	103	82			+0.50			
DRV210M-4-06	●		21	159	105	84			+0.45			
DRV215M-4-06	●		21.5	161	107	86			+0.35			
DRV220M-4-06	●		22	163	109	88			+0.30			
S25- DRV225M-4-07	●	2	22.5	165	111	90	25	32	+0.90	SB-3060TRP	DTPM-10	Outer edge SCMT070305-□□-E Inner edge SCMT070310-□□-I
DRV230M-4-07	●		23	167	113	92			+0.80			
DRV235M-4-07	●		23.5	169	115	94			+0.75			
DRV240M-4-07	●		24	171	117	96			+0.70			
DRV245M-4-07	●		24.5	173	119	98			+0.65			
DRV250M-4-07	●		25	175	121	100			+0.60			
DRV255M-4-07	●		25.5	177	123	102			+0.50			
DRV260M-4-07	●		26	179	125	104			+0.45			
S32- DRV270M-4-09	●	2	27	190	131	108	32	41	+1.05	SB-3573TRP	DTPM-10	Outer edge SCMT090405-□□-E Inner edge SCMT090410-□□-I
DRV280M-4-09	●		28	194	135	112			+0.95			
DRV290M-4-09	●		29	198	139	116			+0.85			
DRV300M-4-09	●		30	202	143	120			+0.75			
DRV310M-4-09	●		31	206	147	124			+0.60			
DRV320M-4-09	●		32	210	151	128			+0.50			

● : Available

# DRV toolholder

## Toolholder dimensions

4D

(Drilling depth: 4 × DC)

Description	Availability	No. of inserts	Dimensions (mm)						Max. radial offset (mm)	Spare parts		Applicable inserts
			DC	OAL	LFS	LU	DCON	DCSFMS		Clamp screw	Wrench	
S40- DRV330M-4-11	●	2	33	227	158	132	40	49	+1.25	SB-4086TRP	DTPM-15	Outer edge SCMT110406-□□-E Inner edge SCMT110410-□□-I
DRV340M-4-11	●		34	231	162	136			+1.15			
DRV350M-4-11	●		35	235	166	140			+1.00			
DRV360M-4-11	●		36	239	170	144			+0.90			
DRV370M-4-11	●		37	243	174	148			+0.80			
DRV380M-4-11	●		38	247	178	152			+0.65			
DRV390M-4-11	●		39	251	182	156			+0.55			
S40- DRV400M-4-14	●	2	40	261	192	160	40	49	+1.75	SB-50120TRPH	TTP-20	Outer edge SCMT140508-□□-E Inner edge SCMT140510-□□-I
<b>NEW</b> DRV410M-4-14	●		41	265	196	164			+1.60			
DRV420M-4-14	●		42	269	200	168			+1.50			
DRV430M-4-14	●		43	273	204	172			+1.40			
DRV440M-4-14	●		44	277	208	176		+1.30				
DRV450M-4-14	●		45	281	212	180		+1.15				
DRV460M-4-14	●		46	285	216	184		+1.05				
DRV470M-4-14	●		47	289	220	188		+0.95				
S50- DRV480M-4-14	●	2	48	293	224	192	50	59	+0.80	SB-60130TRP	TTP-20	Outer edge SCMT170608-□□-E Inner edge SCMT170610-□□-I
<b>NEW</b> DRV490M-4-14	●		49	297	228	196			+0.70			
S50- DRV500M-4-17	●	2	50	298	229	200	50	59	+2.10	SB-60130TRP	TTP-20	Outer edge SCMT170608-□□-E Inner edge SCMT170610-□□-I
<b>NEW</b> DRV510M-4-17	●		51	302	233	204			+1.95			
DRV520M-4-17	●		52	306	237	208			+1.85			
DRV530M-4-17	●		53	310	241	212			+1.75			
DRV540M-4-17	●		54	314	245	216			+1.65			
DRV550M-4-17	●		55	318	249	220		+1.50				
DRV560M-4-17	●		56	322	253	224		+1.40				
DRV570M-4-17	●		57	326	257	228		+1.30				
DRV580M-4-17	●		58	330	261	232		+1.15				
DRV590M-4-17	●		59	334	265	236		+1.05				
DRV600M-4-17	●		60	338	269	240		+0.95				
							64					

When offset drilling, reduce feed rate to 0.06 mm/rev or less  
See page 21 for adjustable sleeve (SHE)

● : Available

### ■ Estimated cutting tolerance (4D)

DC	Estimated cutting tolerance (mm)
φ12 - φ39	+0.35 0
φ40 - φ60	+0.40 0

The above values are estimates.  
These values may change due to machine, workpiece, clamping power, and cutting conditions.

# DRV toolholder

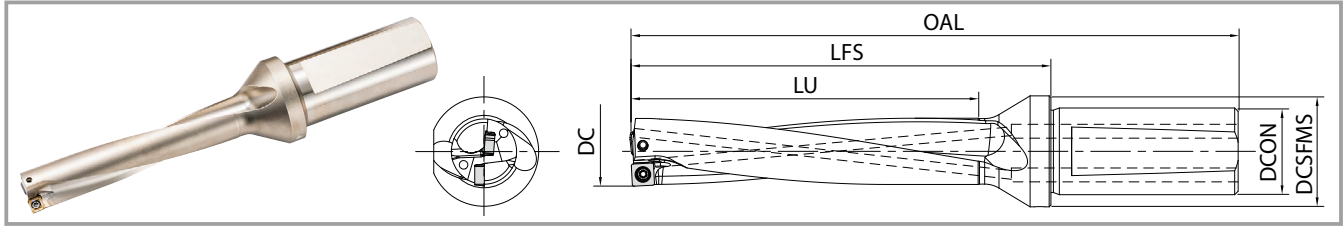

## Toolholder dimensions

**5D**

(Drilling depth: 5 × DC)

Description	Availability	No. of inserts	Dimensions (mm)						Max. radial offset (mm)	Spare parts		Applicable inserts
			DC	OAL	LFS	LU	DCON	DCSFMS		Clamp screw	Wrench	
S20- DRV120M-5-03	●	2	12	118	75	60	20	27	+0.25	SB-2037TRP	FTP-6	Outer edge LCMT030203-□□-E Inner edge LCMT030205-□□-I
S20- DRV130M-5-03	●		13	123	80	65			+0.15			
S20- DRV140M-5-04	●	2	14	134	91	70	20	27	+0.40	SB-2037TRP	FTP-6	Outer edge SCMT040205-□□-E Inner edge SCMT040209-□□-I
S20- DRV150M-5-04	●		15	139	96	75			+0.30			
S25- DRV160M-5-05	●	2	16	158	104	80	25	32	+0.40	SB-2041TRP	FTP-6	Outer edge SCMT050205-□□-E Inner edge SCMT050210-□□-I
S25- DRV170M-5-05	●		17	163	109	85			+0.30			
S25- DRV180M-5-05	●		18	168	114	90			+0.20			
S25- DRV190M-5-06	●		19	170	116	95			+0.65			
S25- DRV200M-5-06	●	2	20	175	121	100	25	32	+0.55	SB-2555TRP	DTPM-8	Outer edge SCMT060205-□□-E Inner edge SCMT060210-□□-I
S25- DRV210M-5-06	●		21	180	126	105			+0.45			
S25- DRV220M-5-06	●		22	185	131	110			+0.30			
S25- DRV230M-5-07	●		23	190	136	115			+0.80			
S25- DRV240M-5-07	●	2	24	195	141	120	25	32	+0.70	SB-3060TRP	DTPM-10	Outer edge SCMT070305-□□-E Inner edge SCMT070310-□□-I
S25- DRV250M-5-07	●		25	200	146	125			+0.60			
S25- DRV260M-5-07	●		26	205	151	130			+0.45			
S32- DRV270M-5-09	●		2	27	217	158			135			
S32- DRV280M-5-09	●	28		222	163	140	+0.95					
S32- DRV290M-5-09	●	29		227	168	145	+0.85					
S32- DRV300M-5-09	●	30		232	173	150	+0.75					
S32- DRV310M-5-09	●	31		237	178	155	+0.60					
S32- DRV320M-5-09	●	32		242	183	160	+0.50					
S40- DRV330M-5-11	●	2	33	260	191	165	40	49	+1.25	SB-4086TRP	DTPM-15	Outer edge SCMT110406-□□-E Inner edge SCMT110410-□□-I
S40- DRV340M-5-11	●		34	265	196	170			+1.15			
S40- DRV350M-5-11	●		35	270	201	175			+1.00			
S40- DRV360M-5-11	●		36	275	206	180			+0.90			
S40- DRV370M-5-11	●		37	280	211	185			+0.80			
S40- DRV380M-5-11	●		38	285	216	190			+0.65			
S40- DRV390M-5-11	●		39	290	221	195			+0.55			
S40- DRV400M-5-14	●	2	40	301	232	200	40	49	+1.75	SB-50120TRPH	TTP-20	Outer edge SCMT140508-□□-E Inner edge SCMT140510-□□-I
S40- DRV410M-5-14	●		41	306	237	205			+1.60			
S40- DRV420M-5-14	●		42	311	242	210			+1.50			
S40- DRV430M-5-14	●		43	316	247	215			+1.40			
S40- DRV440M-5-14	●		44	321	252	220		+1.30				
S40- DRV450M-5-14	●		45	326	257	225		+1.15				
S40- DRV460M-5-14	●		46	331	262	230		+1.05				
S40- DRV470M-5-14	●		47	336	267	235		+0.95				
S50- DRV480M-5-14	●	2	48	341	272	240	50	59	+0.80	SB-60130TRP	TTP-20	Outer edge SCMT170608-□□-E Inner edge SCMT170610-□□-I
S50- DRV490M-5-14	●		49	346	277	245			+0.70			
S50- DRV500M-5-17	●	2	50	348	279	250	50	59	+2.10	SB-60130TRP	TTP-20	Outer edge SCMT170608-□□-E Inner edge SCMT170610-□□-I
S50- DRV510M-5-17	●		51	353	284	255			+1.95			
S50- DRV520M-5-17	●		52	358	289	260			+1.85			
S50- DRV530M-5-17	●		53	363	294	265			+1.75			
S50- DRV540M-5-17	●		54	368	299	270			+1.65			
S50- DRV550M-5-17	●		55	373	304	275			+1.50			
S50- DRV560M-5-17	●		56	378	309	280	+1.40					
S50- DRV570M-5-17	●		57	383	314	285	+1.30					
S50- DRV580M-5-17	●		58	388	319	290	+1.15					
S50- DRV590M-5-17	●		59	393	324	295	+1.05					
S50- DRV600M-5-17	●		60	398	329	300	+0.95					

When offset drilling, reduce feed rate to 0.05 mm/rev or less - See page 21 for adjustable sleeve (SHE)

### ■ Estimated cutting tolerance (5D)

●: Available

DC	Estimated cutting tolerance (mm)
ø12 - ø39	+0.35 0
ø40 - ø60	+0.40 0

The left values are estimates.  
These values may change due to machine, workpiece, clamping power, and cutting conditions.

# DRV toolholder

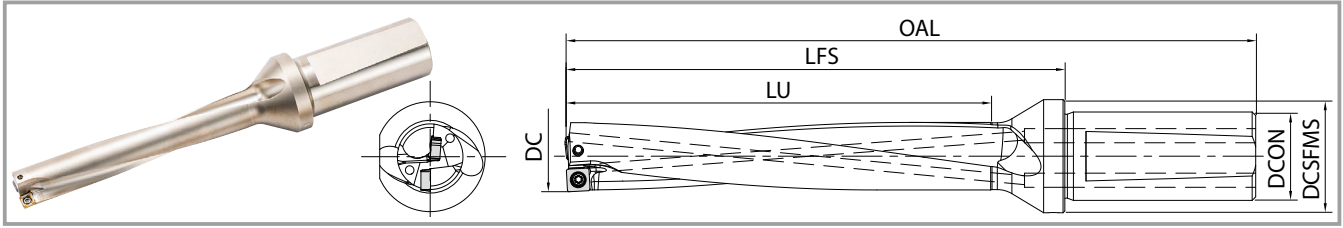

## Toolholder dimensions

6D

(Drilling depth: 6 × DC)

Description	Availability	No. of inserts	Dimensions (mm)						Max. radial offset (mm)	Spare parts		Applicable inserts
			DC	OAL	LFS	LU	DCON	DCSFMS		Clamp screw	Wrench	
S20- DRV120M-6-03	●	2	12	130	87	72	20	27	+0.25	SB-2037TRP	FTP-6	Outer edge LCMT030203-□□-E Inner edge LCMT030205-□□-I
DRV130M-6-03	●		13	136	93	78			+0.15			
S20- DRV140M-6-04	●	2	14	148	105	84	20	27	+0.40	SB-2037TRP	FTP-6	Outer edge SCMT040205-□□-E Inner edge SCMT040209-□□-I
DRV150M-6-04	●		15	154	111	90			+0.30			
S25- DRV160M-6-05	●	2	16	174	120	96	25	32	+0.40	SB-2041TRP	FTP-6	Outer edge SCMT050205-□□-E Inner edge SCMT050210-□□-I
DRV170M-6-05	●		17	180	126	102			+0.30			
DRV180M-6-05	●		18	186	132	108			+0.20			
S25- DRV190M-6-06	●	2	19	189	135	114	25	32	+0.65	SB-2555TRP	DTPM-8	Outer edge SCMT060205-□□-E Inner edge SCMT060210-□□-I
DRV200M-6-06	●		20	195	141	120			+0.55			
DRV210M-6-06	●		21	201	147	126			+0.45			
DRV220M-6-06	●		22	207	153	132			+0.30			
S25- DRV230M-6-07	●	2	23	213	159	138	25	32	+0.80	SB-3060TRP	DTPM-10	Outer edge SCMT070305-□□-E Inner edge SCMT070310-□□-I
DRV240M-6-07	●		24	219	165	144			+0.70			
DRV250M-6-07	●		25	225	171	150			+0.60			
DRV260M-6-07	●		26	231	177	156			+0.45			
S32- DRV270M-6-09	●	2	27	244	185	162	32	41	+1.05	SB-3573TRP	DTPM-10	Outer edge SCMT090405-□□-E Inner edge SCMT090410-□□-I
DRV280M-6-09	●		28	250	191	168			+0.95			
DRV290M-6-09	●		29	256	197	174			+0.85			
DRV300M-6-09	●		30	262	203	180			+0.75			
DRV310M-6-09	●		31	268	209	186			+0.60			
DRV320M-6-09	●		32	274	215	192			+0.50			
S40- DRV330M-6-11	●	2	33	293	224	198	40	49	+1.25	SB-4086TRP	DTPM-15	Outer edge SCMT110406-□□-E Inner edge SCMT110410-□□-I
DRV340M-6-11	●		34	299	230	204			+1.15			
DRV350M-6-11	●		35	305	236	210			+1.00			
DRV360M-6-11	●		36	311	242	216			+0.90			
DRV370M-6-11	●		37	317	248	222			+0.80			
DRV380M-6-11	●		38	323	254	228			+0.65			
DRV390M-6-11	●		39	329	260	234			+0.55			
S40- NEW DRV400M-6-14	●	2	40	341	272	240	40	49	+1.75	SB-50120TRPH	TTP-20	Outer edge SCMT140508-□□-E Inner edge SCMT140510-□□-I
DRV410M-6-14	●		41	347	278	246			+1.60			
DRV420M-6-14	●		42	353	284	252			+1.50			
DRV430M-6-14	●		43	359	290	258			+1.40			
DRV440M-6-14	●		44	365	296	264			+1.30			
DRV450M-6-14	●		45	371	302	270			+1.15			
S50- NEW DRV500M-6-17	●	2	50	398	329	300	50	59	+2.10	SB-60130TRP	TTP-20	Outer edge SCMT170608-□□-E Inner edge SCMT170610-□□-I
DRV550M-6-17	●		55	428	359	330			+1.50			
DRV600M-6-17	●		60	458	389	360			64			

When offset drilling, reduce feed rate to 0.04 mm/rev or less · See page 21 for adjustable sleeve (SHE)

● : Available

### ■ Estimated cutting tolerance (6D)

DC	Estimated cutting tolerance (mm)
φ12 - φ39	+0.45 0
φ40 - φ60	+0.50 0

The left values are estimates.  
These values may change due to machine, workpiece, clamping power, and cutting conditions.







# DRV insert

Usage classification				P	Carbon steel • Alloy steel		☆	★		★		
★: 1st recommendation (High speed and highly efficient machining) ☆: 2nd recommendation (Stable machining oriented)					M	Mold steel		☆	★		★	
				K		Stainless steel		☆	★		★	
Shape	Application	Description	Dimensions (mm)					Angle	MEGACOAT	CVD coated carbide		MEGACOAT NANO
			IC W1/L	S	D1	RE	AN	PR1225	CA520D	CA415D	PR1535	
 LCMT SCMT General purpose	Outer edge	LCMT	030203-GM-E	4.40/5.54	2.0	2.3	0.3	7°	●	●	●	
		SCMT	040205-GM-E	4.80	2.2	2.4	0.5	7°	●	●	●	
			050205-GM-E	5.25	2.6	2.4	0.5	7°	●	●	●	
			060205-GM-E	6.40	2.8	2.9	0.5	7°	●	●	●	
			070305-GM-E	7.65	3.2	3.5	0.5	7°	●	●	●	
			090405-GM-E	9.10	4.1	4.0	0.5	7°	●	●	●	
			110406-GM-E	11.00	4.5	4.6	0.6	7°	●	●	●	
			140508-GM-E	13.80	5.0	5.7	0.8	7°	●	●	●	
 LCMT SCMT Tough edge	NEW	LCMT	030203-GH-E	4.40/5.54	2.0	2.3	0.3	7°	●	●	●	
		SCMT	040205-GH-E	4.80	2.2	2.4	0.5	7°	●	●	●	
			050205-GH-E	5.25	2.6	2.4	0.5	7°	●	●	●	
			060205-GH-E	6.40	2.8	2.9	0.5	7°	●	●	●	
			070305-GH-E	7.65	3.2	3.5	0.5	7°	●	●	●	
			090405-GH-E	9.10	4.1	4.0	0.5	7°	●	●	●	
			110406-GH-E	11.00	4.5	4.6	0.6	7°	●	●	●	
		NEW	140508-GH-E	13.80	5.0	5.7	0.8	7°	●	●	●	
 LCMT SCMT For soft steel machining		SCMT	040205-XM-E	4.80	2.2	2.4	0.5	7°	●	●		
			050205-XM-E	5.25	2.6	2.4	0.5	7°	●	●		
			060205-XM-E	6.40	2.8	2.9	0.5	7°	●	●		
			070305-XM-E	7.65	3.2	3.5	0.5	7°	●	●		
			090405-XM-E	9.10	4.1	4.0	0.5	7°	●	●		
			110406-XM-E	11.00	4.5	4.6	0.6	7°	●	●		
		NEW	140508-XM-E	13.80	5.0	5.7	0.8	7°	●	●		
			170608-XM-E	16.80	6.58	6.9	0.8	7°	●	●		
 LCMT SCMT For stainless steel machining		LCMT	030203-SM-E	4.40/5.54	2.0	2.3	0.3	7°	●	●		
		SCMT	040205-SM-E	4.80	2.2	2.4	0.5	7°	●	●		
			050205-SM-E	5.25	2.6	2.4	0.5	7°	●	●		
			060205-SM-E	6.40	2.8	2.9	0.5	7°	●	●		
			070305-SM-E	7.65	3.2	3.5	0.5	7°	●	●		
			090405-SM-E	9.10	4.1	4.0	0.5	7°	●	●		
			110406-SM-E	11.00	4.5	4.6	0.6	7°	●	●		
		NEW	140508-SM-E	13.80	5.0	5.7	0.8	7°	●	●		
		170608-SM-E	16.80	6.58	6.9	0.8	7°	●	●			

\* LCMT03\*\*\* is a 2-edge insert

●: Available

# DRV insert

Usage classification				P	Carbon steel • Alloy steel		☆	★		★		
★: 1st recommendation (High speed and highly efficient machining) ☆: 2nd recommendation (Stable machining oriented)				M	Stainless steel		☆	★		★		
				K	Cast iron		☆		★	★		
Shape	Application	Description	Dimensions (mm)					Angle	MEGACOAT	CVD coated carbide		MEGACOAT NANO
			IC W1/L	S	D1	RE	AN	PR1225	CA520D	CA415D	PR1535	
 <p>LCMT</p>  <p>SCMT</p> <p>General purpose</p>		LCMT 030205-GM-I	4.16/5.37	2.0	2.3	0.5	7°				●	
		SCMT 040209-GM-I	5.00	2.2	2.4	0.9	7°				●	
		050210-GM-I	5.70	2.6	2.4	1.0	7°				●	
		060210-GM-I	6.90	2.8	2.9	1.0	7°				●	
		070310-GM-I	8.20	3.2	3.5	1.0	7°				●	
		090410-GM-I	9.80	4.1	4.0	1.0	7°				●	
		110410-GM-I	11.90	4.5	4.6	1.0	7°				●	
		140510-GM-I	14.90	5.0	5.7	1.0	7°				●	
 <p>LCMT</p>  <p>SCMT</p> <p>Tough edge</p>	NEW	LCMT 030205-GH-I	4.16/5.37	2.0	2.3	0.5	7°				●	
		SCMT 040209-GH-I	5.00	2.2	2.4	0.9	7°				●	
		050210-GH-I	5.70	2.6	2.4	1.0	7°				●	
		060210-GH-I	6.90	2.8	2.9	1.0	7°				●	
		070310-GH-I	8.20	3.2	3.5	1.0	7°				●	
		090410-GH-I	9.80	4.1	4.0	1.0	7°				●	
		110410-GH-I	11.90	4.5	4.6	1.0	7°				●	
		140510-GH-I	14.90	5.0	5.7	1.0	7°				●	
 <p>SCMT</p> <p>For soft steel machining</p>		SCMT 040209-XM-I	5.00	2.2	2.4	0.9	7°				●	
		050210-XM-I	5.70	2.6	2.4	1.0	7°				●	
		060210-XM-I	6.90	2.8	2.9	1.0	7°				●	
		070310-XM-I	8.20	3.2	3.5	1.0	7°				●	
		090410-XM-I	9.80	4.1	4.0	1.0	7°				●	
		110410-XM-I	11.90	4.5	4.6	1.0	7°				●	
		140510-XM-I	14.90	5.0	5.7	1.0	7°				●	
		170610-XM-I	17.90	6.58	6.9	1.0	7°				●	
 <p>LCMT</p>  <p>SCMT</p> <p>For stainless steel machining</p>		LCMT 030205-SM-I	4.16/5.37	2.0	2.3	0.5	7°				●	
		SCMT 040209-SM-I	5.00	2.2	2.4	0.9	7°				●	
		050210-SM-I	5.70	2.6	2.4	1.0	7°				●	
		060210-SM-I	6.90	2.8	2.9	1.0	7°				●	
		070310-SM-I	8.20	3.2	3.5	1.0	7°				●	
		090410-SM-I	9.80	4.1	4.0	1.0	7°				●	
		110410-SM-I	11.90	4.5	4.6	1.0	7°				●	
		140510-SM-I	14.90	5.0	5.7	1.0	7°				●	
170610-SM-I	17.90	6.58	6.9	1.0	7°				●			

\* LCMT03\*\*\* is a 2-edge insert

● : Available





For MagicDrill DRV

# Chamfering attachment

Free-positioning according to the drilling depth  
Versatile chamfering attachment

## 1 Double inserts provide high efficiency machining

2 inserts allow for increased feed rates  
Low cutting force reduces chattering during increased feed rates

## 2 Excellent chip evacuation

Chip flow grooves are designed to follow the flutes of the drill body delivering excellent chip evacuation

## 3 High chattering resistance

Molded chipbreaker on chamfering insert reduces cutting force  
Special insert design prevents fracturing on the edge  
Economical 2 edge inserts

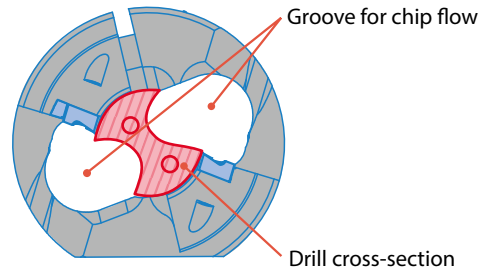

Unique insert design

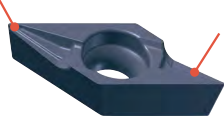

Molded chipbreaker

Unique insert with 2 cutting edges for chamfering attachment

Two inserts

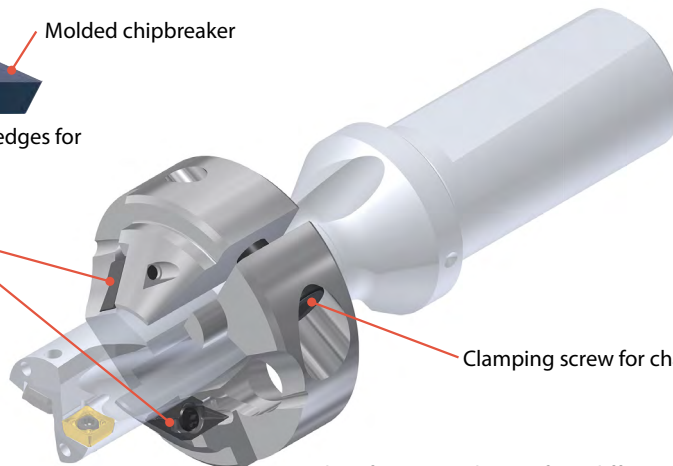

Clamping screw for chamfering attachment

Chamfering attachment for 2 different size drills

### Chattering resistance comparison (In-house evaluation)

Provided good surface finish on the chamfer without chattering

DRV-CH-20  
(Cutting dia.  $\varnothing 20$ )



DRV-CH-20  
Smooth surface without chattering

Competitor O  
(Cutting dia.  $\varnothing 20$ )



Competitor O  
Chattering occurred on the chamfer

Cutting conditions

Vc = 100 m/min  
f = 0.15 mm/rev

Vc = 120 m/min  
f = 0.10 mm/rev

Vc = 120 m/min  
f = 0.12 mm/rev

Workpiece: S45C  
Machine: Machining center BT-50  
 $\varnothing 20$ -3D, H = 30 mm, C2.0

## Chamfering attachment

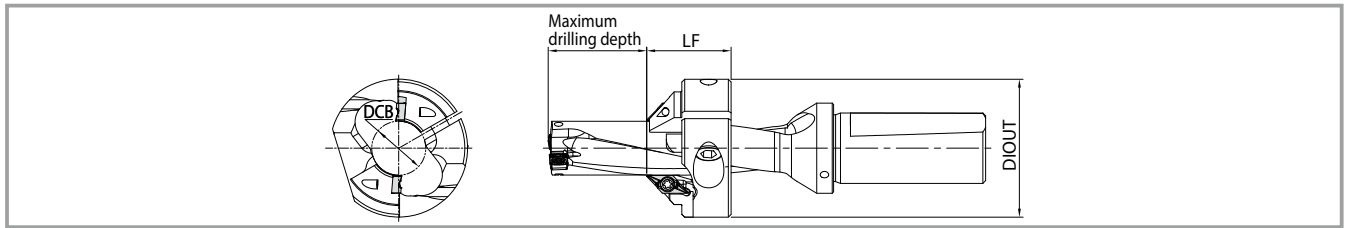

Description	Availability	Applicable drill bodies	Dimensions (mm)			Applicable inserts	Parts							
			DIOUT	DCB	LF		Clamp screw	Wrench	Clamping screw	Wrench				
DRV-CH17	●	S25-DRV165M-○-05 S25-DRV170M-○-05	47	16.2	30	CH0503-45	SB-3080TR	FT-10	HH6X18	LW-5				
DRV-CH18	●	S25-DRV175M-○-05 S25-DRV180M-○-05	47	17.2	30									
DRV-CH19	●	S25-DRV185M-○-05 S25-DRV190M-○-06	49	18.2	30									
DRV-CH20	●	S25-DRV195M-○-06 S25-DRV200M-○-06	49	19.2	30									
DRV-CH21	●	S25-DRV205M-○-06 S25-DRV210M-○-06	49	20.2	30									
DRV-CH22	●	S25-DRV215M-○-06 S25-DRV220M-○-06	49	21.2	30									
DRV-CH23	●	S25-DRV225M-○-07 S25-DRV230M-○-07	51	22.2	30									
DRV-CH24	●	S25-DRV235M-○-07 S25-DRV240M-○-07	51	23.2	30									
DRV-CH25	●	S25-DRV245M-○-07 S25-DRV250M-○-07	53	24.2	30									
DRV-CH26	●	S25-DRV255M-○-07 S25-DRV260M-○-07	53	25.2	30									
DRV-CH27	●	S32-DRV265M-○-09 S32-DRV270M-○-09	64	26	35								HH8X20	LW-6

## Maximum drilling depth • Chamfering depths

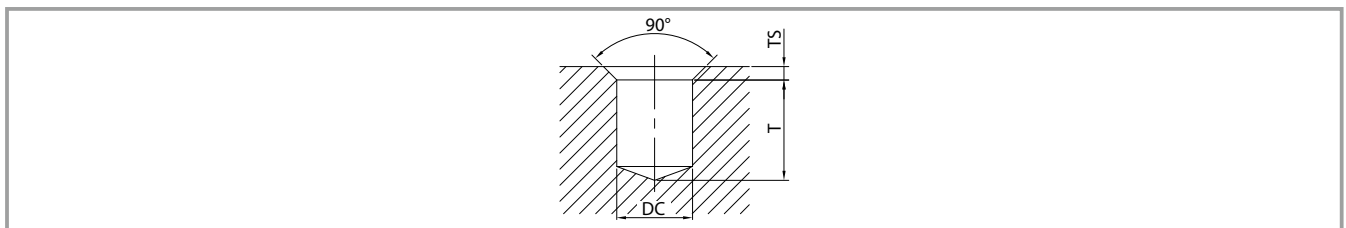

Drilling diameter (mm)	Maximum drilling depth T (mm)					Maximum chamfering depth (mm)	Applicable chamfering attachment
	2D drill	3D drill	4D drill	5D drill	6D drill		
DC						2.5	
ø16.5	0.5	17	33.5	-	-		DRV-CH17
ø17	1.5	18.5	35.5	52.5	69.5		DRV-CH18
ø17.5	2.5	20	37.5	-	-		DRV-CH19
ø18	3.5	21.5	39.5	57.5	75.5		DRV-CH20
ø18.5	4.5	23	41.5	-	-		DRV-CH21
ø19	5.5	24.5	43.5	62.5	81.5		DRV-CH22
ø19.5	6.5	26	45.5	-	-		DRV-CH23
ø20	7.5	27.5	47.5	67.5	87.5		DRV-CH24
ø20.5	8.5	29	49.5	-	-		DRV-CH25
ø21	9.5	30.5	51.5	72.5	93.5		DRV-CH26
ø21.5	10.5	32	53.5	-	-		DRV-CH27
ø22	11.5	33.5	55.5	77.5	99.5		
ø22.5	12.5	35	57.5	-	-		
ø23	13.5	36.5	59.5	82.5	105.5		
ø23.5	14.5	38	61.5	-	-		
ø24	15.5	39.5	63.5	87.5	111.5		
ø24.5	16.5	41	65.5	-	-		
ø25	17.5	42.5	67.5	92.5	117.5		
ø25.5	18.5	44	69.5	-	-		
ø26	19.5	45.5	71.5	97.5	123.5		
ø26.5	-	47	-	-	-		
ø27	16.5	43.5	75.5	97.5	124.5		

## Applicable inserts

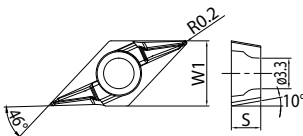
Shape		Description	Dimensions (mm)		MEGACOAT NANO	Applicable chamfering attachment
			W1	S	PR1535	
		CH0503-45	7.05	3.18	●	DRV-CH ○○

●: Available

## How to install chamfering attachment

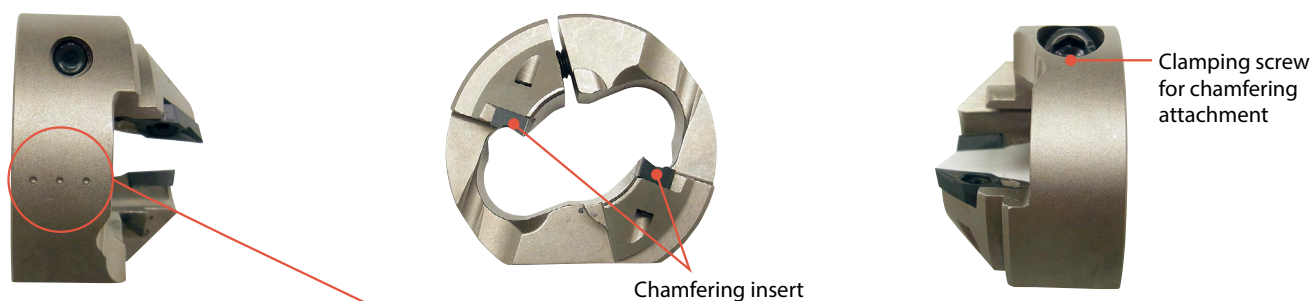

Identification on inner edge

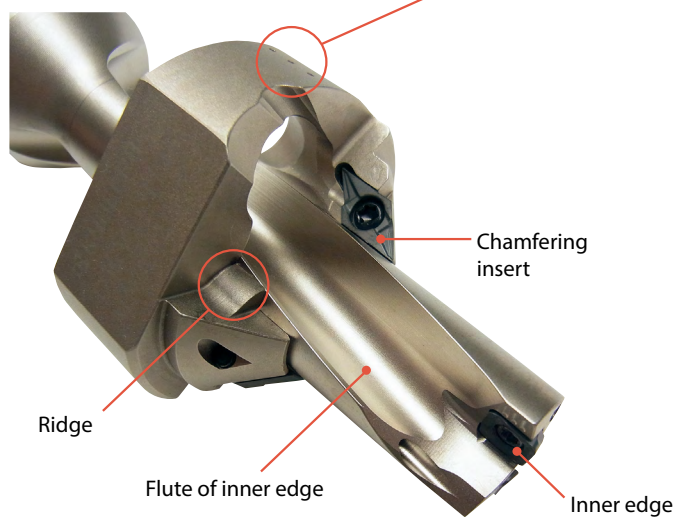

### Instructions

- 1) Install the attachment over the DRV body so that "• • •" mark on the side of the attachment aligns with the inside flute edge (see image).
- 2) Adjust the position to avoid interference between the chamfering inserts, chamfering attachment ridges, and drill body flutes. Then fasten the clamp screw with the recommended torque below.

### Recommended torque

Chamfering attachment description	Torque (N • m)	Clamping screw	Wrench
DRV-CH17 ~ CH26	10	HH6X18	LW-5
DRV-CH27	14	HH8X20	LW-6

**Recommended cutting conditions (2D, 3D, 4D) ★ 1st recommendation ☆ 2nd recommendation**

**■ DRV recommended cutting conditions (Wet)**

Workpiece	Recommended insert grade (Cutting conditions Vc: m/min)										Cutting dia. DC (mm)	Holder type (Drilling depth)				Holder type (Drilling depth)			
	PVD coated carbide				CVD coated carbide							2D,3D				4D			
	PR1225				CA520D				CA415D			f (mm/rev)				f (mm/rev)			
	GM	GH	XM	SM	GM	GH	XM	SM	GM	GH		GM	GH	XM	SM	GM	GH	XM	SM
Low carbon steel (S45C, S15C etc.)	-	-	★ 120- 200	☆ 120- 200	-	-	★ 150- 280	☆ 150- 280	-	-	012 - 013.5	-	-	-	0.04 - 0.06	-	-	-	0.04 - 0.06
	-	-	-	-	-	-	-	-	-	-	014 - 015.5	-	-	0.04 - 0.09	0.04 - 0.07	-	-	0.04 - 0.08	0.04 - 0.07
	-	-	-	-	-	-	-	-	-	-	016 - 018.5	-	-	0.04 - 0.10	0.04 - 0.08	-	-	0.04 - 0.08	0.04 - 0.08
	-	-	-	-	-	-	-	-	-	-	019 - 022	-	-	0.04 - 0.12	0.04 - 0.08	-	-	0.04 - 0.10	0.04 - 0.08
	-	-	-	-	-	-	-	-	-	-	022.5 - 026	-	-	0.04 - 0.14	0.06 - 0.10	-	-	0.04 - 0.12	0.05 - 0.10
	-	-	-	-	-	-	-	-	-	-	026.5 - 032	-	-	0.06 - 0.14	0.06 - 0.10	-	-	0.04 - 0.12	0.05 - 0.10
	-	-	-	-	-	-	-	-	-	-	033 - 039	-	-	0.06 - 0.14	0.06 - 0.10	-	-	0.06 - 0.12	0.05 - 0.10
-	-	-	-	-	-	-	-	-	-	040 - 060	-	-	0.06 - 0.16	0.08 - 0.12	-	-	0.06 - 0.16	0.05 - 0.10	
Carbon steel (S45C etc.)	★ 100- 180	☆ 100- 180	☆ 100- 180	☆ 100- 180	★ 150- 280	☆ 150- 280	☆ 150- 280	☆ 150- 280	-	-	012 - 013.5	0.04 - 0.14	0.04 - 0.14	-	0.04 - 0.10	0.04 - 0.10	0.04 - 0.10	-	0.04 - 0.08
	-	-	-	-	-	-	-	-	-	-	014 - 015.5	0.04 - 0.14	0.04 - 0.14	0.04 - 0.10	0.04 - 0.10	0.04 - 0.10	0.04 - 0.10	0.04 - 0.08	0.04 - 0.08
	-	-	-	-	-	-	-	-	-	-	016 - 018.5	0.06 - 0.16	0.06 - 0.16	0.06 - 0.12	0.06 - 0.12	0.05 - 0.12	0.05 - 0.12	0.04 - 0.10	0.05 - 0.10
	-	-	-	-	-	-	-	-	-	-	019 - 026	0.08 - 0.20	0.08 - 0.20	0.06 - 0.14	0.06 - 0.14	0.07 - 0.16	0.07 - 0.16	0.04 - 0.12	0.05 - 0.12
	-	-	-	-	-	-	-	-	-	-	026.5 - 032	0.08 - 0.20	0.08 - 0.20	0.06 - 0.14	0.06 - 0.14	0.07 - 0.16	0.07 - 0.16	0.04 - 0.12	0.05 - 0.12
	-	-	-	-	-	-	-	-	-	-	033 - 039	0.08 - 0.20	0.08 - 0.20	0.06 - 0.16	0.06 - 0.14	0.07 - 0.16	0.07 - 0.16	0.06 - 0.14	0.05 - 0.12
-	-	-	-	-	-	-	-	-	-	040 - 060	0.08 - 0.20	0.08 - 0.20	0.06 - 0.18	0.06 - 0.14	0.07 - 0.16	0.07 - 0.16	0.06 - 0.16	0.05 - 0.12	
Alloy steel (SCM, SCr etc.)	★ 100- 160	☆ 100- 160	☆ 100- 160	-	★ 140- 220	☆ 140- 220	☆ 140- 220	-	-	-	012 - 013.5	0.04 - 0.12	0.04 - 0.12	-	-	0.04 - 0.10	0.04 - 0.10	-	-
	-	-	-	-	-	-	-	-	-	-	014 - 015.5	0.04 - 0.14	0.04 - 0.14	-	-	0.04 - 0.10	0.04 - 0.10	-	-
	-	-	-	-	-	-	-	-	-	-	016 - 018.5	0.06 - 0.16	0.06 - 0.16	-	-	0.05 - 0.12	0.05 - 0.12	-	-
	-	-	-	-	-	-	-	-	-	-	019 - 039	0.08 - 0.20	0.08 - 0.20	-	-	0.07 - 0.16	0.07 - 0.16	-	-
Mold steel (SKD etc.)	☆ 80-150	★ 80-150	-	-	☆ 130- 210	★ 130- 210	-	-	-	-	012 - 015.5	0.04 - 0.08	0.04 - 0.08	-	-	0.04 - 0.07	0.04 - 0.07	-	-
	-	-	-	-	-	-	-	-	-	-	016 - 018.5	0.06 - 0.12	0.06 - 0.12	-	-	0.05 - 0.10	0.05 - 0.10	-	-
	-	-	-	-	-	-	-	-	-	-	019 - 032	0.08 - 0.15	0.08 - 0.15	-	-	0.06 - 0.12	0.06 - 0.12	-	-
	-	-	-	-	-	-	-	-	-	-	033 - 039	0.08 - 0.15	0.08 - 0.15	-	-	0.06 - 0.12	0.06 - 0.12	-	-
Stainless steel (Austenitic)	-	-	-	★ 70-140	-	-	-	★ 140- 200	-	-	012 - 015.5	-	-	-	0.04 - 0.10	-	-	-	0.04 - 0.08
	-	-	-	-	-	-	-	-	-	-	016 - 018.5	-	-	-	0.06 - 0.12	-	-	-	0.05 - 0.11
	-	-	-	-	-	-	-	-	-	-	019 - 060	-	-	-	0.06 - 0.14	-	-	-	0.06 - 0.12
Gray cast iron (FC)	☆ 100- 150	★ 100- 150	-	-	-	-	-	-	☆ 150- 220	★ 150- 220	012 - 013.5	0.08 - 0.14	0.08 - 0.14	-	-	0.06 - 0.10	0.06 - 0.10	-	-
	-	-	-	-	-	-	-	-	-	-	014 - 015.5	0.08 - 0.14	0.08 - 0.14	-	-	0.06 - 0.12	0.06 - 0.12	-	-
	-	-	-	-	-	-	-	-	-	-	016 - 018.5	0.08 - 0.18	0.08 - 0.18	-	-	0.08 - 0.16	0.08 - 0.16	-	-
	-	-	-	-	-	-	-	-	-	-	019 - 039	0.08 - 0.20	0.08 - 0.20	-	-	0.08 - 0.18	0.08 - 0.18	-	-
Nodular cast iron (FCD)	☆ 80-120	★ 80-120	-	-	-	-	-	-	☆ 120- 180	★ 120- 180	012 - 015.5	0.08 - 0.12	0.08 - 0.12	-	-	0.06 - 0.10	0.06 - 0.10	-	-
	-	-	-	-	-	-	-	-	-	-	016 - 018.5	0.08 - 0.16	0.08 - 0.16	-	-	0.08 - 0.14	0.08 - 0.14	-	-
	-	-	-	-	-	-	-	-	-	-	019 - 039	0.08 - 0.18	0.08 - 0.18	-	-	0.08 - 0.16	0.08 - 0.16	-	-
	-	-	-	-	-	-	-	-	-	-	040 - 060	0.08 - 0.18	0.08 - 0.18	-	-	0.08 - 0.16	0.08 - 0.16	-	-

Internal coolant is recommended

# Recommended cutting conditions (5D, 6D) ★ 1st recommendation ☆ 2nd recommendation

## ■ DRV recommended cutting conditions (Wet)

Workpiece	Recommended insert grade (Cutting conditions Vc: m/min)										Cutting dia. DC (mm)	Holder type (Drilling depth)				Holder type (Drilling depth)							
	PVD coated carbide					CVD coated carbide						5D				6D							
	PR1225					CA520D						CA415D				f (mm/rev)				f (mm/rev)			
	GM	GH	XM	SM		GM	GH	XM	SM			GM	GH	XM	SM	GM	GH	XM	SM				
Low carbon steel (S45C, S15C etc.)	-	-	★ 120-200	☆ 120-200	-	-	-	★ 150-280	☆ 150-280	-	-	-	-	0.03 - 0.05	-	-	-	0.03 - 0.05					
	-	-	-	-	-	-	-	-	-	-	-	-	0.04 - 0.07	0.04 - 0.06	-	-	0.04 - 0.06	0.04 - 0.06					
	-	-	-	-	-	-	-	-	-	-	-	-	0.04 - 0.08	0.04 - 0.06	-	-	0.04 - 0.06	0.04 - 0.06					
	-	-	-	-	-	-	-	-	-	-	-	-	0.04 - 0.10	0.04 - 0.07	-	-	0.04 - 0.07	0.04 - 0.07					
	-	-	-	-	-	-	-	-	-	-	-	-	0.04 - 0.12	0.04 - 0.08	-	-	0.04 - 0.08	0.04 - 0.07					
	-	-	-	-	-	-	-	-	-	-	-	-	0.04 - 0.12	0.04 - 0.08	-	-	0.04 - 0.08	0.04 - 0.07					
	-	-	-	-	-	-	-	-	-	-	-	-	0.05 - 0.12	0.04 - 0.10	-	-	0.04 - 0.09	0.04 - 0.08					
	-	-	-	-	-	-	-	-	-	-	-	-	0.06 - 0.14	0.04 - 0.10	-	-	0.06 - 0.12	0.04 - 0.08					
Carbon steel (S45C etc.)	★ 100-180	☆ 100-180	☆ 100-180	☆ 100-180	★ 150-280	☆ 150-280	☆ 150-280	☆ 150-280	☆ 150-280	-	-	-	-	0.04 - 0.08	0.04 - 0.08	0.04 - 0.07	0.04 - 0.07	0.03 - 0.05					
	-	-	-	-	-	-	-	-	-	-	-	-	0.04 - 0.08	0.04 - 0.07	0.04 - 0.06	0.04 - 0.06	0.04 - 0.06	0.04 - 0.06					
	-	-	-	-	-	-	-	-	-	-	-	-	0.05 - 0.10	0.05 - 0.08	0.05 - 0.08	0.05 - 0.08	0.05 - 0.07	0.05 - 0.07					
	-	-	-	-	-	-	-	-	-	-	-	-	0.06 - 0.12	0.05 - 0.10	0.05 - 0.10	0.06 - 0.10	0.05 - 0.08	0.05 - 0.08					
	-	-	-	-	-	-	-	-	-	-	-	-	0.06 - 0.12	0.05 - 0.10	0.06 - 0.10	0.06 - 0.10	0.05 - 0.08	0.05 - 0.08					
	-	-	-	-	-	-	-	-	-	-	-	-	0.06 - 0.12	0.05 - 0.10	0.06 - 0.10	0.06 - 0.10	0.05 - 0.08	0.05 - 0.08					
	-	-	-	-	-	-	-	-	-	-	-	-	0.06 - 0.12	0.05 - 0.10	0.06 - 0.10	0.06 - 0.10	0.05 - 0.08	0.05 - 0.08					
	-	-	-	-	-	-	-	-	-	-	-	-	0.06 - 0.12	0.05 - 0.10	0.06 - 0.10	0.06 - 0.10	0.05 - 0.08	0.05 - 0.08					
Alloy steel (SCM, SCr etc.)	★ 100-160	☆ 100-160	☆ 100-160	-	★ 140-220	☆ 140-220	☆ 140-220	-	-	-	-	-	-	0.04 - 0.08	-	-	0.03 - 0.05	0.03 - 0.05					
	-	-	-	-	-	-	-	-	-	-	-	-	0.04 - 0.08	0.04 - 0.08	0.04 - 0.07	0.04 - 0.06	0.04 - 0.06	-					
	-	-	-	-	-	-	-	-	-	-	-	-	0.05 - 0.10	0.05 - 0.10	0.05 - 0.08	0.05 - 0.08	0.05 - 0.08	-					
	-	-	-	-	-	-	-	-	-	-	-	-	0.06 - 0.12	0.06 - 0.12	0.06 - 0.10	0.06 - 0.10	0.06 - 0.10	-					
	-	-	-	-	-	-	-	-	-	-	-	-	0.06 - 0.12	0.06 - 0.12	0.06 - 0.10	0.06 - 0.10	0.06 - 0.10	-					
Mold steel (SKD etc.)	☆ 80-150	★ 80-150	-	-	☆ 130-210	★ 130-210	-	-	-	-	-	-	-	0.04 - 0.06	-	-	0.03 - 0.05	0.03 - 0.05					
	-	-	-	-	-	-	-	-	-	-	-	-	0.04 - 0.06	0.04 - 0.06	0.04 - 0.05	0.04 - 0.05	-	-					
	-	-	-	-	-	-	-	-	-	-	-	-	0.04 - 0.08	0.04 - 0.08	0.04 - 0.06	0.04 - 0.06	-	-					
	-	-	-	-	-	-	-	-	-	-	-	-	0.05 - 0.10	0.05 - 0.10	0.05 - 0.08	0.05 - 0.08	-	-					
	-	-	-	-	-	-	-	-	-	-	-	-	0.05 - 0.10	0.05 - 0.10	0.05 - 0.08	0.05 - 0.08	-	-					
Stainless steel (Austenitic)	-	-	-	★ 70-140	-	-	-	-	★ 140-200	-	-	-	-	0.04 - 0.08	-	-	-	0.03 - 0.05					
	-	-	-	-	-	-	-	-	-	-	-	-	-	0.04 - 0.08	-	-	-	0.04 - 0.06					
	-	-	-	-	-	-	-	-	-	-	-	-	-	0.04 - 0.10	-	-	-	0.04 - 0.09					
	-	-	-	-	-	-	-	-	-	-	-	-	-	0.06 - 0.12	-	-	-	0.06 - 0.10					
Gray cast iron (FC)	☆ 100-150	★ 100-150	-	-	-	-	-	-	-	☆ 150-220	★ 150-220	-	-	0.04 - 0.10	0.04 - 0.10	-	-	0.04 - 0.08					
	-	-	-	-	-	-	-	-	-	-	-	-	-	0.06 - 0.12	0.06 - 0.12	0.06 - 0.10	0.06 - 0.10						
	-	-	-	-	-	-	-	-	-	-	-	-	-	0.06 - 0.14	0.06 - 0.14	0.06 - 0.12	0.06 - 0.12						
	-	-	-	-	-	-	-	-	-	-	-	-	-	0.06 - 0.14	0.06 - 0.14	0.06 - 0.12	0.06 - 0.12						
Nodular cast iron (FCD)	☆ 80-120	★ 80-120	-	-	-	-	-	-	-	☆ 120-180	★ 120-180	-	-	0.04 - 0.08	0.04 - 0.08	-	-	0.03 - 0.05					
	-	-	-	-	-	-	-	-	-	-	-	-	-	0.04 - 0.08	0.04 - 0.08	0.04 - 0.06	0.04 - 0.06						
	-	-	-	-	-	-	-	-	-	-	-	-	-	0.06 - 0.10	0.06 - 0.10	0.06 - 0.08	0.06 - 0.08						
	-	-	-	-	-	-	-	-	-	-	-	-	-	0.06 - 0.12	0.06 - 0.12	0.06 - 0.10	0.06 - 0.10						

Internal coolant is recommended

## Cutting conditions by application

Application	Plain surface	Slant surface	Half cylindrical	Hole expansion	Pre-drilled surface	Concave surface	Stacked plates	
Workpiece								
Vc (m/min)	See recommended cutting conditions above	120 (PVD insert is recommended for outer edge)						
f (mm/rev)	See recommended cutting conditions above	Half of the above recommended conditions is recommended				Concave surface: Half of the above recommended conditions is recommended		Not recommended
						Continuous: See recommended cutting conditions above		
Coolant (Internal coolant)	Yes							

## Insert grade selection guide

Select CVD for the outer edge when performing high speed and high efficiency machining. Machining for high efficiency, abrasion resistance and long tool life.

Select PVD for the outer edge when for stable machining and a better surface finish.

PVD is recommended for the outer edge if chattering occurs or machining with lathe is not available even if cutting conditions are increased.

**1st recommendation**  
(High speed and high efficiency machining)

**Stable machining oriented**  
(1st recommendation for lathe machining)

Outer edge: CVD (CA520D/CA415D)

Inner edge: PVD (PR1535)

Outer edge: PVD (PR1225)

Inner edge: PVD (PR1535)

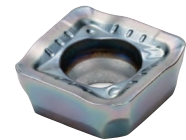
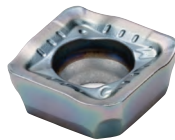

## Shape of the hole bottom

Chip size	DC	A	Chip size	DC	A	Chip size	DC	A	Chip size	DC	A	Chip size	DC	A		
03	12.0	0.70	06	19.0	1.2	07	22.5	1.2	09	26.5	1.2	14	40.0	1.9		
	12.5			19.5			23.0			27.0			41.0			
	13.0			20.0			23.5			27.5			42.0			
	13.5			20.5			24.0			28.0			43.0			
04	14.0	1.0		21.0	1.3	07	24.5	1.3		09	28.5		1.3	14	44.0	2.0
	14.5			21.5			25.0				29.0				45.0	
	15.0			22.0			25.5				29.5				46.0	
	15.5			26.0			30.0				30.5				47.0	
05	16.0	1.1	09	1.4	14	31.0	1.4	17	31.5		1.5	17	48.0		2.2	
	16.5					31.5			32.0				50.0			
	17.0					32.0			31.5				51.0			
	17.5	1.5				17			52.0		2.1					
	18.0								53.0							
18.5	1.2	17		33.0		1.5	17		54.0	2.2						
18.5				34.0					35.0		55.0					
06	1.2	1.2		11		1.6	17		36.0	1.6	17		56.0	2.3	17	57.0
			37.0		58.0											
			38.0		59.0											
			39.0		60.0											
			39.0		1.7			59.0	2.4							
			39.0		1.7			60.0								

Common for 2D, 3D, 4D, 5D and 6D drills.  
\* The above values are estimate values.  
(Varies by approximately ±0.1 mm depending on workpiece and cutting conditions, etc.)

## Cautions for machining

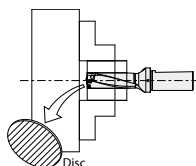

In case of through-hole machining, disc may be generated and ejected outward when drilling a hole. Be sure to install covers to protect against dangers if using a machine without the covers including general-purpose lathes, etc.

# Adjustable sleeve (Cutting dia./Center height adjustment)

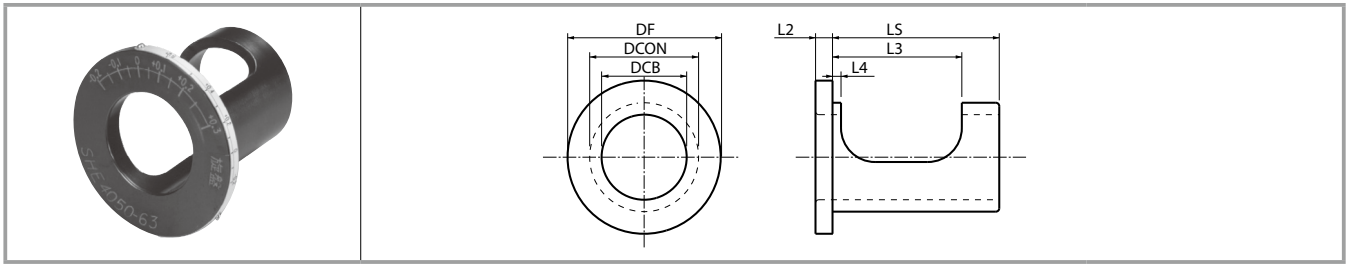

## Sleeve dimensions

Description	Availability	Dimensions (mm)								Dia. adjustment range*	Center height adjustment range
		DCB	DCON	DF	LS	L2	L3	L4			
SHE 2025-43	●	20	25	41	43	4	36	3.0	+0.4 ~ -0.2	+0.2 ~ -0.15	
2532-48	●	25	32	49	48	6	38	2.5	+0.4 ~ -0.2	+0.2 ~ -0.15	
3240-53	●	32	40	58	53	6	43	2.5	+0.4 ~ -0.2	+0.2 ~ -0.15	
4050-63	●	40	50	74	63	6	49	3.0	+0.6 ~ -0.2	+0.2 ~ -0.2	

\* Dia. adjustment range refers to the cutting diameter.

● : Available

### 1 Diameter adjustment: For machining center

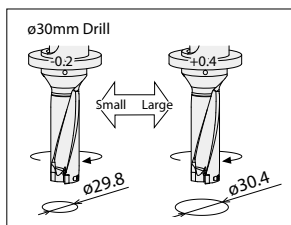

#### ■ Diameter adjustment range (mm)

Shank dia.	Adjustment range
ø20	+0.4 ~ -0.2
ø25	
ø32	
ø40	+0.6 ~ -0.2

### 2 Center height adjustment: Fewer height adjustment problems for lathes

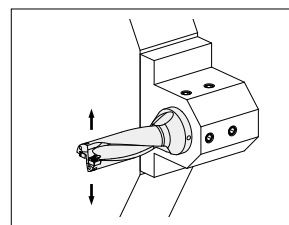

#### ■ Center height adjustment range (mm)

Shank dia.	Adjustment range
ø20	+0.2 ~ -0.15
ø25	
ø32	
ø40	+0.3 ~ -0.2

## How to use

### 1 Hole diameter adjustment when drilling

1. Align the scale at the flange periphery of the sleeve to the center of the coolant plug of the drill. (Fig. 1)
2. When making the hole diameter bigger, rotate the sleeve in the (+) direction and to make it smaller, rotate the sleeve in the (-) direction.
3. When rotating the sleeve, insert the wrench supplied with the drill into the hole on the flange periphery to rotate the sleeve.
4. Using the bottom screw of the side-lock arbor, firmly tighten the drill directly through the sleeve's window.

The upper screw should be tightened slightly so that the sleeve will not be damaged.

#### Caution:

- Not for use with collet chuck type arbor.
- Check the actual cutting diameter after adjusting.

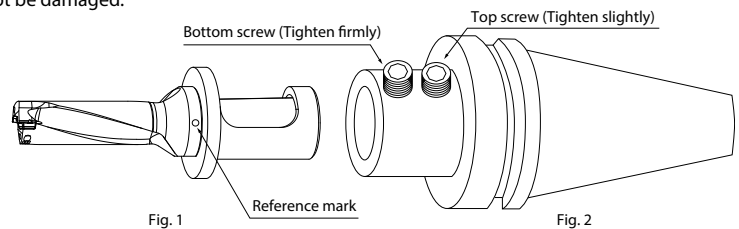

### 2 Center-height adjustment for lathes

Most of the problems encountered with a turning lathe are center-height deviations. The center height is appropriate if a core of about 0.5 mm diameter remains at the center of the hole. Center-height adjustment is necessary when no core remains or if the core diameter is more than 1 mm.

1. Align the drill with the outer insert face parallel to the X-axis of the tool turret. (Fig. 4)
2. Align the scale (for the lathe) on the flange face of the sleeve to the center of the reference mark.
3. When no core remains, rotate the sleeve in the (+) direction to make the core larger, and when the core diameter is more than 1mm, rotate the sleeve in the (-) direction to make the core smaller.
4. When rotating the sleeve, insert the wrench supplied with the drill into the hole of the flange and then rotate the sleeve.
5. After completing the adjustment, tighten the drill directly through the window on the sleeve.

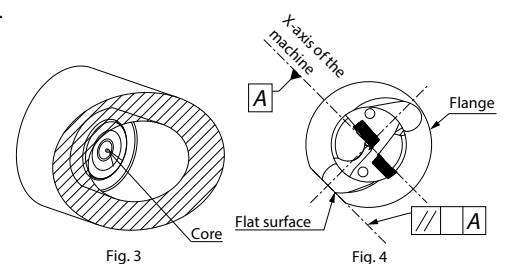

#### Caution:

Depending on amount of the center height adjustment, the hole diameter may change. It is recommended that the hole diameter is checked after the center height adjustment.

# Lathe installation

1. The top face of the outer insert should be parallel to the X-axis to allow for offset cutting.  
(Cutting diameter can be changed by moving X-axis.)
2. It is recommended to set the outer insert as shown in Fig. 1 with the outer insert facing the operator. (Fig. 1)  
(It is also possible to use it by setting it in 180° reverse position)  
If the lathe has two turrets, when installing the drill into the lower turret, the outer insert should be set to face the operator.  
(It is also possible to use it by setting at 180° reverse position)

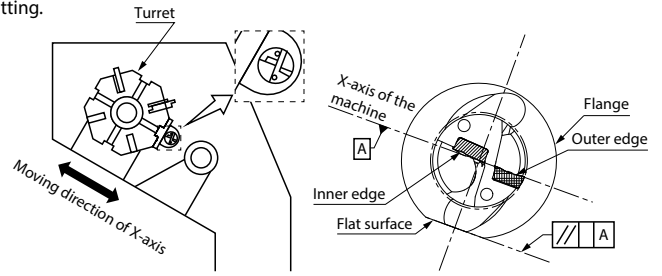

Fig. 1 Installed into the lathe

# Cutting diameter adjustment

## 1 Cutting diameter adjustment

1. Cutting diameter is adjusted by moving X-axis.  
The moving direction of the X-axis depends on the position of the toolholder.
2. For making the hole diameter larger, slide the tool along the X-axis toward the outer insert side. (Fig. 2, Fig. 3)  
For making the hole diameter smaller, slide the tool along the X-axis in the opposite direction.  
(This movement of the axis is called "Offset")  
Be sure not to make the hole diameter smaller than the drill diameter by 0.2 mm or more. Otherwise, the toolholder will interfere with the drilled hole. (Fig. 4)  
Ex.: When using  $\varnothing 20$  drill, the hole diameter must not be smaller than 19.8 mm

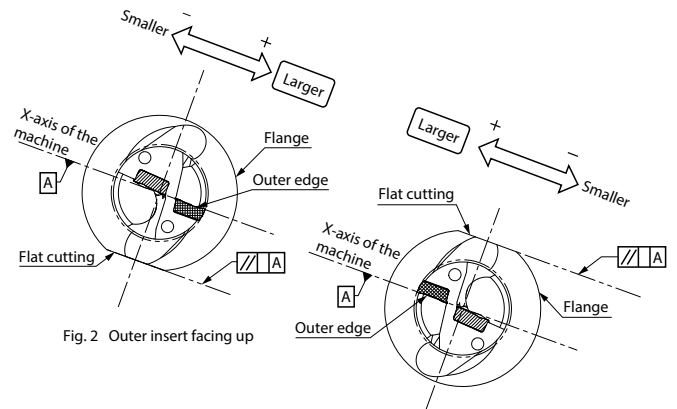

Fig. 2 Outer insert facing up

Fig. 3 Outer insert facing down

## 2 Offset limit of the cutting diameter

For the maximum limit of the cutting diameter, refer to "Max. offset (Radial)" in the toolholder dimensions table.  
(The figure in the toolholder dimensions table shows how much it is possible to offset the drill in the radial direction.)  
Ex.: When using  $\varnothing 20$  drill, for example, it is possible to make a hole up to  $\varnothing 21.1$  since "Max. offset (Radial)" is +0.55 mm.

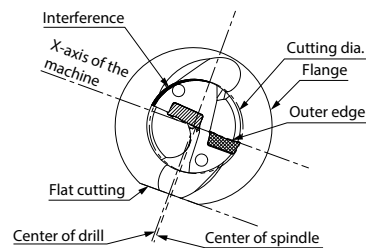

Fig. 4 Excessive offset (For smaller hole diameter)

# Center height adjustment

## 1 Center height of the inner insert

When installing inner insert as shown in Fig. 1, It will be set around 0.05 mm below the center of spindle. (Fig. 5)  
This is the normal position of the center height. However, in case that the turret of the lathe is out of the center of spindle, sometimes the inner insert may be set above or below the center. For stable machining, it is essential to check the center height carefully

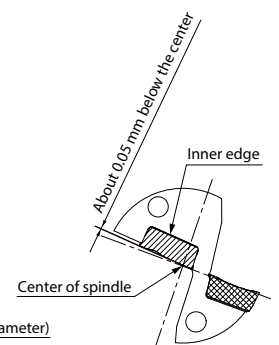

Fig. 5 Front view of the drill

## 2 How to check the center height

For checking the center height of the inner insert, see the core which remains at the center of the bottom of the drilled hole. If the center height is in the normal position, a core about 0.5 mm in diameter, will remain after machining. (Fig. 6)  
Adjustment of center height is required if a large core diameter of 1 mm or more remains.  
\* The drilled hole for verification purposes needs to be machined at approximately 10 mm in depth and at a feed rate of 0.1 mm/rev or lower.

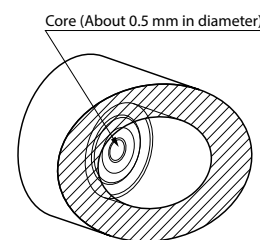

Fig. 6 Center core



### 3 Center height adjustment

#### 1. When there are no remaining cores and the vicinity of the drill center of the inner edge is damaged

This happens when the inner insert is set above the center height. (Fig. 7)

How to adjust
<p>A. Install the drill rotated by 180° Most problems will be solved by this method (Fig. 8)</p>
<p>B. If the core diameter becomes too large after the above adjustment, install the drill by rotating 90° counter-clockwise as shown in Fig. 9 (outer edge is positioned lower) and adjust the center height by moving the tool in the X-axis direction. (However, this will make it impossible to adjust the cutting diameter) Caution: When installing the drill in the opposite direction (outer insert is positioned above), the cutting diameter will become smaller, which may cause the drill body to interfere with the drilled hole. The best solution is to readjust the center position of the turret itself.</p>

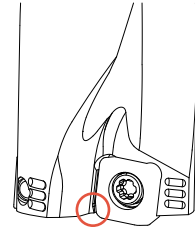

Fig. 7 Insert breakage near the center of the drill

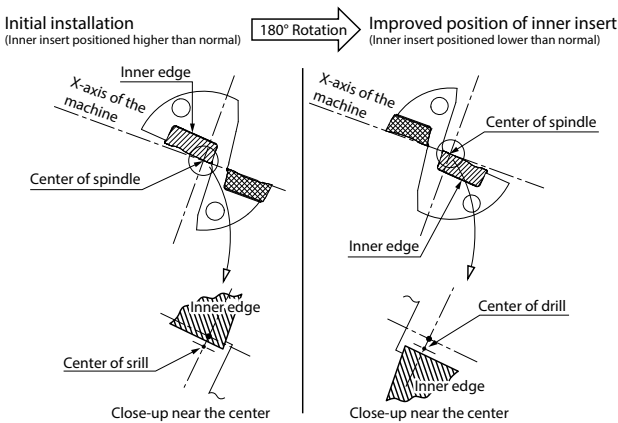

Fig. 8

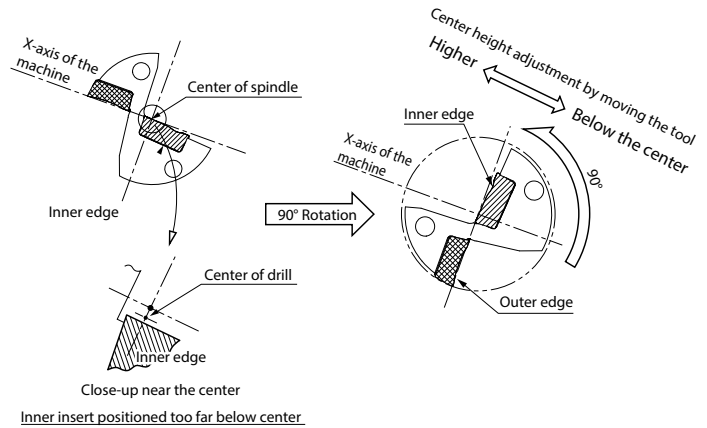

Fig. 9

#### 2. Core with excessively large diameter (more than 1 mm)

This occurs when the inner insert is excessively below the center. This condition causes poor chip evacuation and an adjustment is required.

How to adjust
<p>Install the drill rotating 90° as shown in Fig. 10. (outer insert is positioned on the upper side) and adjust the center height by moving tool in the X-axis direction. (However, this will make it impossible to adjust the cutting diameter) Caution: When installing the drill in the opposite direction (outer insert is positioned lower), the cutting diameter will become smaller, which may cause the drill body to interfere with the drilled hole. The best solution is to readjust the center position of the turret itself.</p>

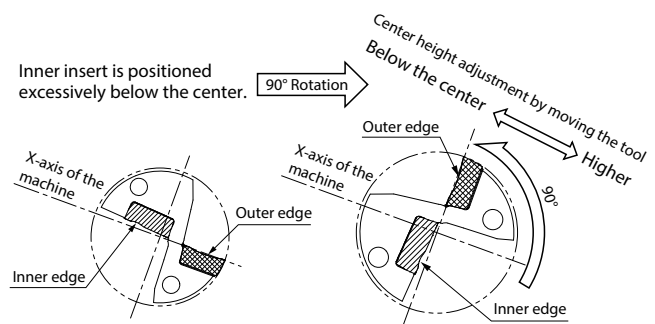

Fig. 10